

KRK BAUSTOFFE

"Geheimnis der Meister"

Wir beruckichtigen alle Details fur Ihre Wohnraume
We consider all the details for your living spaces
Yařam alanlarınız icin butun detayları duřunuyouz

/ Produktkatalog
/ Product Catalogue
/ urun Kataloęu



KR BAUSTOFFE

"Geheimnis der Meister"

ÜBER UNS / ABOUT US / HAKKIMIZDA



Unter Einbeziehung der besten Lifestyle-Marken, die zu einer Leidenschaft für seine Kunden, Mitarbeiter, Geschäftspartner und sogar Wettbewerber werden, arbeitet KRK BAUSTOFFE weiterhin mit dem Ziel, ein Global Player in seinen Bereichen zu werden.

KRK BAUSTOFFE ist mit seiner Erfahrung und seinem Wissen im Bau- und Bauchemiesektor tätig und wächst mit seinen neuen Investitionen in den von ihm bedienten Sektor weiter. Mit ihren qualifizierten und professionellen Mitarbeitern bedient sie ihre Kunden mit überlegener Technologie, hoher Markenqualität und einem dynamischen Personal.



Incorporating the best-in-class lifestyle brands that will become a passion for its customers, employees, business partners and even competitors, KRK BAUSTOFFE continues to work with the aim of becoming a global player in its fields.

Operating in the Construction and Construction Chemicals sector with its experience and knowledge, KRK BAUSTOFFE continues to grow with its new investments in the sector it serves. With its qualified and professional staff, it serves its customers with superior technology, high brand quality and a dynamic human resource.



Müşterileri, çalışanları, iş ortakları ve hatta rakipleri için bir tutkuya dönüşecek, sınıfının en iyisi yaşam tarzı markalarını bünyesinde barındıran KRK BAUSTOFFE, çalıştığı alanlarda küresel bir oyuncu olma hedefiyle çalışmalarına devam ediyor.

Tecrübe ve birikimleriyle İnşaat, Yapı Kimyasalları sektöründe faaliyet gösteren KRK BAUSTOFFE, hizmet verdiği sektörde yeni yatırımlarıyla da büyümesini sürdürüyor. Kaliteli ve profesyonel kadrosuyla müşterilerine üstün teknoloji, yüksek marka kalitesi ve dinamik bir insan kaynağı ile hizmet veriyor.

Hinter dem von KRK BAUSTOFFE erzielten und angestrebten Erfolg steht ein kundenorientierter und produktivitätszentrierter Managementansatz. Als Ergebnis dieses Ansatzes zielt es darauf ab, durch seine Zusammenarbeit mit angesehenen Marken auf der ganzen Welt dauerhaft und anders in der Branche zu sein.

KRK BAUSTOFFE bietet ganzheitliche Dienstleistungen im Bereich der Projekt- und Produktentwicklung und versteht es, Systemlösungen zu schaffen, die sich durch Qualität und Design auszeichnen, indem sie sich ständig erneuern und für jedes Detail genaue, ausgewählte und technologische Lösungen als unverwechselbares Element finden.

Behind the success achieved and targeted by KRK BAUSTOFFE is a customer-oriented and productivity-centered management approach. As a result of this approach, it aims to be permanent and different in the sector with its collaborations with reputable brands around the world.

Providing holistic services in the field of project and product development, KRK BAUSTOFFE considers creating system solutions that stand out with their quality and design by constantly renewing itself and finding accurate, selected and technological solutions for each detail as a distinctive element.

KRK BAUSTOFFE'nin ulaştığı ve hedeflediği başarının arkasında, müşteri odaklı ve verimliliği merkez alan bir yönetim yaklaşımı yer alıyor. Bu yaklaşımın bir sonucu olarak, dünya ölçeğinde saygın markalarla yaptığı iş birlikleriyle, sektörde kalıcı ve farklı olmayı hedefliyor.

Proje ve ürün geliştirme , alanında bütünsel hizmetler sunan KRK BAUSTOFFE, sürekli kendisini yenileyen ve her bir detaya doğru ,seçilmiş ve teknolojik çözümler bularak kalite ve tasarımıyla öne çıkan sistem çözümlerini yaratmayı ayırtıcı bir unsur olarak görmektedir.



**Keramikleber
und Fugenfüller**

**Ceramic Adhesive
and Joint Fillers**

**Seramik Yapıştırıcı
ve Derz Dolgular**

KRK BAUSTOFFE

"Geheimnis der Meister"

BODENKLEBER

- Ceramic and Tile Adhesive Mortar
- Seramik ve Fayans Yapıştırma Harcı

 Es ist ein zementgebundener, hochstabiler Keramikklebstoff, verstärkt mit chemischen Zusätzen und Polymeren, der zum Verkleben von Fliesen, Keramik, Fliesen und Glasmosaiken verwendet wird.

Farbe: Grau und Weiß

EINSATZBEREICHE:

- Drinnen und draußen,
- An der Wand und am Boden,
- Es wird zum Verkleben von Fliesen, Keramik, Fliesen und Glasmosaiken verwendet.

 It is a cement-based, highly stable ceramic adhesive reinforced with chemical additives and polymers, used for bonding tiles, ceramics, tiles and glass mosaics.

Color : Gray and White

USAGE AREAS:

- Indoors and outdoors,
- On the wall and on the floor,
- It is used for bonding tiles, ceramics, tiles and glass mosaics.

 Çimento esaslı, kimyasal katkılar ve polimerler ile takviye edilmiş, fayans, seramik, çini ve cam mozaik yapıştırılmasında kullanılan yüksek stabiliteye sahip seramik yapıştırıcıdır.

Renk : Gri ve Beyaz

KULLANIM ALANLARI:

- İç ve dış mekânlarda,
- Duvarda ve zeminde,
- Fayans, seramik, çini ve cam mozaiklerin yapıştırılmasında kullanılır.

Seramik ve Fayans Yapıştırma Harcı



VERPACKUNG / PACKAGING / AMBALAJ

25 Kg.

Kraftbeutel / Kraft Bag / Kraft Torba

TECHNISCHE SPEZIFIKATIONEN / TECHNICAL SPECIFICATIONS / TEKNİK ÖZELLİKLERİ

Farbe / Colour / Renk	Grau weiß/Grey-White/Gri-Beyaz
Anfangshaftkraft / Initial adhesive strength / Başlangıç yapışma dayanımı	≥ 0,5 N/mm ²
Haftfestigkeit nach Eintauchen in Wasser/Adhesion strength after immersion in water/Suya daldırma sonrası yapışma dayanımı	≥ 0,5 N/mm ²
Haftfestigkeit nach Heißealterung / Adhesion strength after hot aging / Sıcakta yaşlandırma sonrası yapışma dayanımı	≥ 0,5 N/mm ²
Temperaturbeständigkeit / Temperature Resistance / Sıcaklık Dayanımı	-30 °C ile +60 °C
Reaktion auf Feuer / Reaction to fire / Yangına tepki	A1

* Numunelerin deneyi gerektirmez, 2000/605/EC sayılı karara göre
- Bu değerler +23±2 °C sıcaklık ve %50±5 bağıl nemli ortam koşulları için verilmiştir.

TEILKLEBER

- Ceramic and Tile Adhesive Mortar
- Seramik ve Fayans Yapıştırma Harcı

 Einkomponentiger, leicht zu verarbeitender keramischer Klebemörtel auf Zementbasis mit reduziertem Schlupf und verlängerter offener Zeit.
E = Verlängerte Laufzeit

EINSATZBEREICHE:

- Im Innen- und Außenbereich der Gebäude,
- Auf Terrassen,
- In Nassbereichen wie Badezimmer und Küche,
- Erzielt gute Ergebnisse auf Oberflächen wie Beton, Putz, Estrich.

 One-component, easy-to-apply cement-based ceramic adhesive mortar with reduced slip and extended open time.
E = Extended run time

USAGE AREAS:

- In the interior and exterior of the buildings,
- On terraces,
- In wet areas such as bathrooms and kitchens,
- Gives good results on surfaces such as concrete, plaster, screed.

 Kayma özelliği azaltılmış, açık bekletme süresi uzatılmış, tek bileşenli kolay uygulanabilen çimento esaslı seramik yapıştırma harcı
E = Uzatılmış çalışma süresi

KULLANIM ALANLARI:

- Binaların iç ve dış mekânlarında,
- Teraslarda,
- Banyo ve mutfak gibi ıslak hacimlerde,
- Beton, sıva, şap gibi yüzeyler üzerinde iyi sonuçlar verir.

Seramik ve Fayans Yapıştırma Harcı



VERPACKUNG / PACKAGING / AMBALAJ

25 Kg.

Kraftbeutel / Kraft Bag / Kraft Torba

TECHNISCHE SPEZIFIKATIONEN / TECHNICAL SPECIFICATIONS / TEKNİK ÖZELLİKLERİ

Farbe / Colour / Renk	Grau weiß/Grey-White/Gri-Beyaz
Anfangshaftkraft / Initial adhesive strength / Başlangıç yapışma dayanımı	≥ 1 N/mm ²
Haftfestigkeit nach Eintauchen in Wasser/Adhesion strength after immersion in water/Suya daldırma sonrası yapışma dayanımı	≥ 1 N/mm ²
Haftfestigkeit nach Heißalterung / Adhesion strength after hot aging / Sıcakta yaşlandırma sonrası yapışma dayanımı	≥ 1 N/mm ²
Anwendungstemperatur / Application Temperature / Uygulama Sıcaklığı	+5 °C +30 °C
Reaktion auf Feuer / Reaction to fire / Yangına tepki	A1

* Numunelerin deneyi gereksizdir, 2000/605/EC sayılı karara göre
- Bu değerler +23±2 °C sıcaklık ve %50±5 bağıl nemli ortam koşulları için verilmiştir.



KRK BAUSTOFFE

"Geheimnis der Meister"

EXTRAKLEBER

- Ceramic and Granite Adhesive Mortar
- Seramik ve Granit Yapıştırma Harcı

 Es handelt sich um einen leistungsstarken, elastischen Klebemörtel auf Zementbasis, der durch Zugabe von Wasser gebrauchsfertig ist. Es kann für die horizontale und vertikale Verklebung von keramischen Beschichtungen im Innen- und Außenbereich verwendet werden.

Es entspricht der TS EN 12004 – C2T-Klasse.
(C2: Kleber auf Zementbasis mit verbesserten Zusatzeigenschaften, T: Reduzierter Schlupf,)

EINSATZBEREICHE:

• Verklebung von Keramik, Granit, Pressziegel, Glasmosaik, Marmor, Ziegel und Natursteinen auf Böden aller Art (Zementoberflächen, Beton, Betonfertigteile etc.) im Innen- und Außenbereich, in vertikaler und horizontaler Anwendung, Es wird in Nassbereichen wie Schwimmbädern, Wassertanks, Bädern etc., in Wand- und Bodenbelägen von Kühlräumen,

 It is a high performance, cement based elastic adhesive mortar that is ready for use by adding water. It can be used for horizontal and vertical bonding of ceramic coatings indoors and outdoors. It complies with TS EN 12004 – C2T class.

(C2: Cement-based adhesive with improved additional properties, T: Reduced slip,)

USAGE AREAS:

• Bonding of ceramic, granite, pressed brick, glass mosaic, marble, brick and natural stones to all kinds of floors (cement-based surfaces, concrete, precast concrete, etc.) indoors and outdoors, in vertical and horizontal applications, It is used in wet areas such as swimming pools, water tanks, bathrooms, etc., in wall and floor coverings of cold storage rooms.

 Su eklenerek kullanıma hazır hale gelen, yüksek performanslı, çimento esaslı elastik yapıştırma harcıdır. Seramik kaplamaların, iç ve dış mekanlarda, yatay ve düşey olarak yapıştırılmasında kullanılabilir. TS EN 12004 – C2T sınıfına uygundur.

(C2: İlave özellikleri geliştirilmiş çimento esaslı yapıştırıcı, T: Kayma özelliği azaltılmış,)

KULLANIM ALANLARI:

• İç ve dış mekânlarda, düşey ve yatay uygulamalarda, seramik, granit, pres tuğla, cam mozaik, mermer, tuğla ve doğal taşların her türlü zemine (çimento esaslı yüzeyler, beton, prekast beton vb...) yapıştırılmasında, • Yüzme havuzu, su deposu, banyo vb.. ıslak hacimlerde, soğuk hava depolarının duvar ve döşeme kaplamalarında, • Binaların dış cephelerinde seramik ve granit yapıştırma işlerinde, tadilat ve onarımlarda, seramik üzerine seramik yapıştırma işlerinde kullanılır.

TECHNISCHE SPEZIFIKATIONEN / TECHNICAL SPECIFICATIONS / TEKNİK ÖZELLİKLERİ

Farbe / Colour / Renk	Grau weiß/Grey-White/Gri-Beyaz
Anfangshaftkraft / Initial adhesive strength / Başlangıç yapışma dayanımı	≥ 1 N/mm ²
Haftfestigkeit nach Eintauchen in Wasser/Adhesion strength after immersion in water/Suya daldırma sonrası yapışma dayanımı	≥ 1 N/mm ²
Haftfestigkeit nach Heißalterung / Adhesion strength after hot aging / Sıcakta yaşlandırma sonrası yapışma dayanımı	≥ 1 N/mm ²
Temperaturbeständigkeit / Temperature Resistance / Sıcaklık Dayanımı	-30 °C ile +80 °C
Auftragsstärke / Application Thickness / Uygulama Kalınlığı	Min. 1mm - Max: 15mm

* Numunelerin deneyi gereksizdir, 2000/605/EC sayılı karara göre
- Bu değerler +23±2 °C sıcaklık ve %50±5 bağıl nemli ortam koşulları için verilmiştir.

Seramik ve Granit Yapıştırma Harcı



VERPACKUNG / PACKAGING / AMBALAJ

25 Kg.

Kraftbeutel / Kraft Bag / Kraft Torba

ELASTOKLEBER

- Flex Ceramic and Tile Adhesive Mortar
- Flex Seramik ve Fayans Yapıştırma Harcı



Es handelt sich um einen leistungsstarken, elastischen Klebemörtel auf Zementbasis, der durch Zugabe von Wasser gebrauchsfertig ist. Es kann für die horizontale und vertikale Verklebung von keramischen Beschichtungen im Innen- und Außenbereich verwendet werden. GEEIGNET FÜR TS EN 12004 - C2TE KLASSE (C2: Kleber auf Zementbasis mit verbesserten Zusatzeigenschaften, T: Reduzierter Schlupf, E: Verlängerte Offenhaltezeit)

EINSATZBEREICHE:

• Verklebung von Keramik, Granit, Pressziegel, Glasmosaik, Marmor, Ziegel und Natursteinen auf Böden aller Art (Zementoberflächen, Beton, Betonfertigteile etc.) im Innen- und Außenbereich, in vertikaler und horizontaler Anwendung, • Es wird in Nassbereichen wie Schwimmbädern, Wassertanks, Badezimmern etc., in Wand- und Bodenbelägen von Kühlräumen eingesetzt.



It is a high performance, cement-based elastic adhesive mortar that is ready for use by adding water. It can be used for horizontal and vertical bonding of ceramic coatings indoors and outdoors. SUITABLE FOR TS EN 12004 - C2TE CLASS (C2: Cement-based adhesive with improved additional properties, T: Reduced slip, E: Extended open hold time)

USAGE AREAS:

• Bonding of ceramic, granite, pressed brick, glass mosaic, marble, brick and natural stones to all kinds of floors (cement-based surfaces, concrete, precast concrete, etc.) indoors and outdoors, in vertical and horizontal applications, • It is used in wet areas such as swimming pools, water tanks, bathrooms, etc., in wall and floor coverings of cold storage rooms,



Su eklenerek kullanıma hazır hale gelen, yüksek performanslı, çimento esaslı elastik yapıştırma harcıdır. Seramik kaplamaların, iç ve dış mekanlarda, yatay ve düşey olarak yapıştırılmasında kullanılabilir. TS EN 12004 - C2TE SINIFINA UYGUNDUR (C2: İlave özellikleri geliştirilmiş çimento esaslı yapıştırıcı, T: Kayma özelliği azaltılmış, E: Uzatılmış açık bekleme süresi)

KULLANIM ALANLARI:

• İç ve dış mekânlarda, düşey ve yatay uygulamalarda, seramik, granit, pres tuğla, cam mozaik, mermer, tuğla ve doğal taşların her türlü zemine (çimento esaslı yüzeyler, beton, prekast beton vb...) yapıştırılmasında, • Yüzme havuzu, su deposu, banyo vb.. ıslak hacimlerde, soğuk hava depolarının duvar ve döşeme kaplamalarında, • Binaların dış cephelerinde seramik ve granit yapıştırma işlerinde, tadilat ve onarımlarda, seramik üzerine seramik yapıştırma işlerinde kullanılır.

TECHNISCHE SPEZIFIKATIONEN / TECHNICAL SPECIFICATIONS / TEKNİK ÖZELLİKLERİ

Farbe / Colour / Renk	Grau weiß/Grey-White/Gri-Beyaz
Anfangshaftkraft / Initial adhesive strength / Başlangıç yapışma dayanımı	≥ 1 N/mm ²
Haftfestigkeit nach Eintauchen in Wasser/Adhesion strength after immersion in water/Suya daldırma sonrası yapışma dayanımı	≥ 1 N/mm ²
Haftfestigkeit nach Heißalterung / Adhesion strength after hot aging / Sıcakta yaşlandırma sonrası yapışma dayanımı	≥ 1 N/mm ²
Temperaturbeständigkeit / Temperature Resistance / Sıcaklık Dayanımı	-30 °C ile +80 °C
Auftragsstärke / Application Thickness / Uygulama Kalınlığı	Min. 1mm - Max: 15mm

* Numunelerin deneyi gerekmeksizin, 2000/605/EC sayılı karara göre
- Bu değerler +23±2 °C sıcaklık ve %50±5 bağıl nemli ortam koşulları için verilmiştir.

Flex Seramik ve Fayans Yapıştırma Harcı



VERPACKUNG / PACKAGING / AMBALAJ

25 Kg.

Kraftbeutel / Kraft Bag / Kraft Torba



KRK BAUSTOFFE

"Geheimnis der Meister"

FLEXOKLEBER

• Superflex Ceramic and Tile Adhesive Mortar
• Süperflex Seramik ve Fayans Yapıştırma Harcı

 Zementbasierte, chemische Additive, Polymere und Mineral hergestellt nach TS EN 12004 durch Verstärkung mit Füllungen, C2TE S1-Klasse, Keramik, Granit, Pressziegel, Glasmosaik, Es ist ein schneller Klebstoff mit hoher Klebeleistung, der zum Verkleben von Marmor und Natursteinen auf allen Arten von Böden verwendet wird.

Norm: Entspricht TS EN 12004 –C2TE S1-Klasse.

(C2: Zementbasierter Klebstoff mit verbesserten Zusatzeigenschaften, T: Reduzierter Schlupf, E: Verlängerte offene Zeit, S1: Flexibel)

EINSATZBEREICHE:

• Innen- und Außenanwendung, vertikale und horizontale Anwendung, Verklebung von Keramik, Granit, Pressziegel, Glasmosaik, Marmor, Ziegel und Naturstein auf allen Arten von Böden (zementbasierte Oberflächen, Beton, Betonfertigteile, etc...) • Schwimmbad, Anwendung in Nassbereichen, Wand- und Bodenbelägen von Kühlräumen, Keramik- und Granitverklebungen im Außenbereich von Gebäuden, Renovierungen und Reparaturen, Keramikverklebungen auf Keramik.

 It is a high performance, cement based elastic adhesive mortar that is ready for use by adding water. It can be used for horizontal and vertical bonding of ceramic coatings indoors and outdoors. It complies with TS EN 12004 –C2T class.

(C2: Cement-based adhesive with improved additional properties, T: Reduced slip,)

USAGE AREAS:

• Bonding of ceramic, granite, pressed brick, glass mosaic, marble, brick and natural stones to all kinds of floors (cement-based surfaces, concrete, precast concrete, etc.) indoors and outdoors, in vertical and horizontal applications, • It is used in wet areas such as swimming pools, water tanks, bathrooms, etc., in wall and floor coverings of cold storage rooms.

 Çimento esaslı, kimyasal katkıları, polimerler ve mineral dolgular ile takviye edilerek TS EN 12004'e göre üretilen, C2TE S1 sınıfı, seramik, granit, pres tuğla, cam mozaik, mermer ve doğal taşların her türlü zemine yapıştırılmasında kullanılan, yüksek yapışma performansına sahip hızlı yapıştırıcıdır.

Standart : TS EN 12004 –C2TE S1 sınıfına uygundur.

(C2: İlave özellikleri geliştirilmiş çimento esaslı yapıştırıcı, T: Kayma özelliği azaltılmış, E: Açık bekletme süresi uzatılmış, S1: Esnek)

Süperflex Seramik ve Fayans Yapıştırma Harcı



VERPACKUNG / PACKAGING / AMBALAJ 20 Kg.

Kraftbeutel / Kraft Bag / Kraft Torba

KULLANIM ALANLARI:

• İç ve dış mekânlarda, duşey ve yatay uygulamalarda, seramik, granit, pres tuğla, cam mozaik, mermer, tuğla ve doğal taşların her türlü zemine (çimento esaslı yüzeyler, beton, prekast beton vb...) yapıştırılmasında, • Yüzme havuzu, su deposu, banyo vb.. ıslak hacimlerde, soğuk hava depolarının duvar ve döşeme kaplamalarında, Binaların dış cephelerinde seramik ve granit yapıştırma işlerinde, tadilat ve onarımlarda, seramik üzerine seramik yapıştırma işlerinde kullanılır.

TECHNISCHE SPEZIFIKATIONEN / TECHNICAL SPECIFICATIONS / TEKNİK ÖZELLİKLERİ

Farbe / Colour / Renk	Grau weiß/Grey-White/Gri-Beyaz
Anfangshaftkraft / Initial adhesive strength / Başlangıç yapışma dayanımı	≥ 1 N/mm ²
Hafffestigkeit nach Eintauchen in Wasser/Adhesion strength after immersion in water/Suya daldırma sonrası yapışma dayanımı	≥ 1 N/mm ²
Hafffestigkeit nach Heißealterung / Adhesion strength after hot aging / Sıcakta yaşlandırma sonrası yapışma dayanımı	≥ 1 N/mm ²
Temperaturbeständigkeit / Temperature Resistance / Sıcaklık Dayanımı	-30 °C ile +80 °C
Auftragsstärke / Application Thickness / Uygulama Kalınlığı	Min. 1mm - Max: 15mm

* Numunelerin deneyi gerekmeksizin, 2000/605/EC sayılı karara göre
- Bu değerler +23±2 °C sıcaklık ve %50±5 bağıl nemli ortam koşulları için verilmiştir.

KRK - FUGA

- Flexibler Fugendichtstoff
- Flexible Joint Sealant
- Esnek Derz Dolgu Malzemesi

 Es handelt sich um ein zementgebundenes, flexibles Fugenfüllmaterial, das resistent gegen Schimmel- und Pilzbildung ist und nicht durch Wasser angegriffen wird.

EINSATZBEREICHE:

- Es dient zum Füllen der Fugenfugen zwischen 2-8 mm von Beschichtungsmaterialien wie Keramik, Granit, Cotto, Klinker, Glasmosaik, Marmor in allen Größen im Innen- und Außenbereich.
- Es wird in horizontalen und vertikalen Anwendungen in Nassbereichen wie Pools und Wassertanks verwendet.
- Es wird an Orten mit starkem Fußgänger- und Lastenverkehr und plötzlichen Temperaturwechseln verwendet, z. B. im Außenbereich, auf Terrassen, Fußbodenheizungen, Lagerhallen.
- Es liefert hervorragende Ergebnisse in Nassbereichen wie Badezimmern, Duschen, Toiletten, an leicht verschmutzten Orten wie Küchen, in horizontalen und vertikalen Anwendungen.

 It is a cement-based, flexible joint filler material that is resistant to mold and fungus formation and is not affected by water.

USAGE AREAS:

- It is used for filling the joint gaps between 2-8 mm of coating materials such as ceramic, granite, cotto, clinker, glass mosaic, marble in all sizes, indoors and outdoors.
- It is used in horizontal and vertical applications in wet areas such as pools and water tanks.
- It is used in places with heavy pedestrian and cargo traffic and sudden temperature changes such as exterior, terrace, underfloor heating system, warehouse.
- It gives excellent results in wet areas such as bathrooms, showers, toilets, in easily dirty places such as kitchens, in horizontal and vertical applications.

 Çimento esaslı, küf ve mantar oluşumuna dirençli yüksek performanslı sudan etkilenmeyen esnek derz dolgu malzemesidir.

KULLANIM ALANLARI:

- İç ve dış mekanda, tüm ebatlardaki seramik, granit, kotto, klinker, cam mozaik, mermer gibi kaplama malzemelerinin 2-8 mm arasındaki derz boşluklarının doldurulmasında kullanılır. • Havuz, su deposu gibi ıslak hacimli mekanlarda yatay ve düşey uygulamalarda kullanılır. • Dış cephe, teras, alttan ısıtmalı sistem, depo gibi yoğun yaya ve yük trafiğinin, ani ısı değişimlerinin olduğu yerlerde kullanılır. • Banyo, duş, tuvalet gibi ıslak hacimlerde, mutfak gibi kolay kirlenebilen mekanlarda, yatay ve düşey uygulamalarda, mükemmel sonuç verir.

Esnek Derz Dolgu Malzemesi



VERPACKUNG / PACKAGING / AMBALAJ

5 Kg. / 20 Kg.

Kraftbeutel / Kraft Bag / Kraft Torba

TECHNISCHE SPEZIFIKATIONEN / TECHNICAL SPECIFICATIONS / TEKNİK ÖZELLİKLERİ

Farbe / Colour / Renk	Weiß Farbe/White-Color/Beyaz-Renkli
Abriebfestigkeit / Abrasion Resistance / Aşınma Dayanımı	< 1000 mm ³
Biegefestigkeit nach trockener Lagerung / Flexural Strength after Dry Storage / Kuru Depolama Sonrası Eğilme Dayanımı	> 3,5 N/mm ²
Druckfestigkeit nach Frost-Tau-Zyklen / Compressive Strength After Freeze-Thaw Cycles / Donma-Çözülme Çevrimleri Sonrası Basınç Dayanımı	> 15 N/mm ²
Schwindung / Shrinkage / Büzülme	< 2mm/m

- Bu değerler +23±2 °C sıcaklık ve %50±5 bağıl nemli ortam koşulları için verilmiştir.



KRK BAUSTOFFE

"Geheimnis der Meister"



Betonreparatur- und
-schutzprodukte

Concrete Repair and
Protection Products

Beton Tamir ve
Koruma Ürünleri

KRK BAUSTOFFE

"Geheimnis der Meister"

KRK-400

- Strukturreparaturmörtel
- Structural Repair Mortar
- Yapısal Tamir Harcı

 Zementbasierter, einkomponentiger, faser- und polymerverstärkter, karbonatisierungsbeständiger, hochfester, nicht schrumpfender, thixotroper Strukturreparaturmörtel.
TS EN 1504-3 R2 Klasse

EINSATZBEREICHE:

- Vorhang-, Stützen- und Balkenreparaturen,
- Bei der Instandsetzung von Betonfertigteilen,
- In Brücken und Viadukten,
- Bei der Bewehrung von Betonelementen,
- In Hafen- und Meeresbauwerken,
- Bei Boden- und Oberflächenreparaturen,
- Schließen von Zugstangen-, Kern-, Stangen- und Rohrleitungsspalten.

 Cement based, single component, fiber and polymer reinforced, carbonation resistant, high strength, non-shrinking, thixotropic structural repair mortar.
TS EN 1504-3 R2 Class

USAGE AREAS:

- Curtain, column and beam repairs,
- In the repair of prefabricated concrete structural elements,
- In bridges and viaducts,
- In the reinforcement of concrete elements,
- In port and marine structures,
- In floors and surface repairs,
- Closing tie-rod, core, rod and plumbing gaps.

 Çimento esaslı, tek bileşenli, fiber ve polimer takviyeli karbonasyona karşı dayanıklı, yüksek mukavemetli büzülme yapmayan, tiksotropik yapısal tamir harcıdır.
TS EN 1504-3 R2 Sınıfı

KULLANIM ALANLARI:

- Perde, kolon ve kiriş onarımlarında,
- Prefabrik beton yapı elemanlarının onarımında,
- Köprü ve viyadüklerde,
- Beton elemanlarının güçlendirilmesinde,
- Liman ve deniz yapılarında,
- Döşemelerde ve yüzey tamiratlarında,
- Tie-rod, karot, tij ve tesisat boşluklarının kapatılmasında.



VERPACKUNG / PACKAGING / AMBALAJ
25 Kg.
Kraftbeutel / Kraft Bag / Kraft Torba

TECHNISCHE SPEZIFIKATIONEN / TECHNICAL SPECIFICATIONS / TEKNİK ÖZELLİKLERİ

Granulatgröße / Granule Size / Granül Boyu	0.1-2.0 mm
25kg. Wasserverhältnis für Paket / 25 kg. Water Ratio for Package / 25 Kg. Paket için Su Oranı	3,75-4,00 litre
Druckfestigkeit / Compressive Strength / Basınç Dayanımı	>20 N/mm ² (1. tag/day/gün) >45 N/mm ² (7. tag/day/gün) >60 N/mm ² (28. tag/day/gün)
Haftkraft / Adhesion Strength / Yapışma Dayanımı	>2 N/mm ² (28. tag/day/gün)
Auftragsstärke / Application Thickness / Uygulama Kalınlığı	10 - 50 mm

KRK-410

- Reparaturmörtel (1-5 mm)
- Repair Mortar (1-5mm)
- Tamir Harcı (1-5mm)

 Zementbasierter, leistungsstarker Einkomponenten-, Spachtelkonsistenz, grober Betonreparatur- und Ausgleichsmörtel.
TS EN 1504-3 R2 Klasse
Öffentliche Arbeiten Artikel-Nr.: 04.613/3-A

EINSATZBEREICHE:

- Bei Oberflächenreparaturen und Feinputzarbeiten von Sichtbeton,
- Als Reparatur- und Ausgleichsmörtel an Wänden und Decken,
- In Vorbereitungen vor der Keramik- und Fliesenbeschichtung,

 Cement-based, high performance, single component, trowel consistency, gross concrete repair and leveling mortar.
TS EN 1504-3 R2 Class
Public Works Item No: 04.613/3-A

USAGE AREAS:

- In surface repairs and fine plaster works of exposed concrete,
- As a repair and leveling mortar on walls and ceilings,
- In preparations before ceramic and tile coating,

 Çimento esaslı, yüksek performans sağlayan, tek bileşenli ve mala kıvamında brüt beton ince tamir ve tesviye harcıdır.
TS EN 1504-3 R2 Sınıfı
Bayındırlık Poz No: 04.613/3-A

KULLANIM ALANLARI:

- Brüt betonların yüzey tamirlerinde ve ince sıva işlerinde,
- Duvar ve tavanlarda tamir ve tesviye harcı olarak,
- Seramik ve fayans kaplama öncesi hazırlıklarda,



VERPACKUNG / PACKAGING / AMBALAJ

25 Kg.

Kraftbeutel / Kraft Bag / Kraft Torba

TECHNISCHE SPEZIFIKATIONEN / TECHNICAL SPECIFICATIONS / TEKNİK ÖZELLİKLERİ

20kg. Wasserverhältnis für Paket / 20 kg. Water Ratio for Package / 20 Kg. Paket için Su Oranı	4,40 litre
Druckfestigkeit / Compressive Strength / Basınç Dayanımı	>15 N/mm ² (28. tag/day/gün)
Haftkraft / Adhesion Strength / Yapışma Dayanımı	>1 N/mm ² (28. tag/day/gün)
Biegefestigkeit / Flexural Strength / Eğilme Dayanımı	>2 N/mm ² (28. tag/day/gün)
Auftragsstärke / Application Thickness / Uygulama Kalınlığı	1 - 5 mm
Reaktion auf Feuer / Reaction to fire / Yangına tepki	A1



KRK BAUSTOFFE

"Geheimnis der Meister"

KRK-420

- Reparaturmörtel (5-20 mm)
- Repair Mortar (5-20mm)
- Tamir Harcı (5-20mm)

 Es ist ein zementbasierter, leistungsstarker, einkomponentiger Betonreparaturmörtel mit Spachtelkonsistenz.

TS EN 1504-3 R2 Klasse

Öffentliche Arbeiten Artikel-Nr.: 04.613/3-A

EINSATZBEREICHE:

- Bei Oberflächenreparaturen und Putzarbeiten von Sichtbeton,
- Als Reparaturmörtel an Wänden und Decken,
- Bei Reparaturen vor der Keramik- und Fliesenbeschichtung,
- Kanten-, Eck- und Säulenreparaturen

 It is cement based, high performance, single component and trowel consistency gross concrete repair mortar.

TS EN 1504-3 R2 Class

Public Works Item No: 04.613/3-A

USAGE AREAS:

- In surface repairs and plastering works of exposed concrete,
- As a repair mortar on walls and ceilings,
- In repairs before ceramic and tile coating,
- Edge, corner and column repairs

 Çimento esaslı, yüksek performans sağlayan, tek bileşenli ve mala kıvamında brüt beton tamir harcıdır.

TS EN 1504-3 R2 Sınıfı

Bayındırlık Poz No: 04.613/3-A

KULLANIM ALANLARI:

- Brüt betonların yüzey tamirlerinde ve sıva işlerinde,
- Duvar ve tavanlarda tamir harcı olarak,
- Seramik ve fayans kaplama öncesi tamiratlarda,
- Kenar, köşe ve kolon tamirlerinde



VERPACKUNG / PACKAGING / AMBALAJ

25 Kg.

Kraftbeutel / Kraft Bag / Kraft Torba

TECHNISCHE SPEZIFIKATIONEN / TECHNICAL SPECIFICATIONS / TEKNİK ÖZELLİKLERİ

25kg. Wasserverhältnis für Paket / 25 kg. Water Ratio for Package / 25 Kg. Paket için Su Oranı	5,50 litre
Druckfestigkeit / Compressive Strength / Basınç Dayanımı	>15 N/mm ² (28. tag/day/gün)
Haftkraft / Adhesion Strength / Yapışma Dayanımı	>1 N/mm ² (28. tag/day/gün)
Biegefestigkeit / Flexural Strength / Eğilme Dayanımı	>2 N/mm ² (28. tag/day/gün)
Auftragsstärke / Application Thickness / Uygulama Kalınlığı	5 - 20 mm
Reaktion auf Feuer / Reaction to fire / Yangına tepki	A1

KRK-500

- Stoßstopfenmaterial
- Shock Plug Material
- Şok Tıkaç Malzemesi



Es ist ein einkomponentiges Abdichtungsmaterial auf Zementbasis, das in 2-3 Sekunden aushärtet, aktives Wasserlecken und -lecks verhindert und wasserabweisende Eigenschaften hat. Es kann direkt auf das aktive Wasserleck aufgetragen werden, ohne es mit Wasser zu vermischen.

EINSATZBEREICHE:

- An Wand und Boden,
- In Wassertanks, Wassertanks, Reservoirs und Wasserstraßen,
- Bei der Verhinderung von aktiven Wasserlecks
- Beim Schneiden von Wasserlecks in statischen Rissen
- Mit Abdichtungsprodukt in Bereichen mit negativem Wasserrisiko
- In Nassbereichen wie Toiletten, Bädern, Schwimmbädern,
- In unterirdischen und oberirdischen Bauwerken, Abwasserkanälen,
- Wird in Fundamenten und Kellerinnenwänden verwendet.



It is a cement-based, single-component waterproofing material that cures in 2-3 seconds, prevents active water leaks and leaks, and has water-repellent properties. It can be applied directly on the active water leak without mixing with water.

USAGE AREAS:

- On the wall and floor,
- In water tanks, water tanks, reservoirs and waterways,
- In the prevention of active water leaks
- In cutting water leaks in static cracks
- With waterproofing product in areas with negative water risk
- In wet areas such as toilets, bathrooms, swimming pools,
- In underground and above-ground structures, sewers,
- It is used in foundations and basement interior walls.



Çimento esaslı, 2-3 saniyede sertleşen, aktif su kaçaklarını ve sızıntılarını engelleyen, su itici özelliğe sahip, tek bileşenli su yalıtım malzemesidir. Su ile karıştırılmadan direk aktif su sızıntısının üzerine uygulanabilir.

KULLANIM ALANLARI:

- Duvar ve zeminde, • Su tankları, su depoları, rezervuarlar ve su yollarında,
- Aktif su kaçaklarının önlenmesinde • Statik çatlaklardaki su sızıntılarının kesilmesinde • Negatif su riski taşıyan alanlarda su yalıtım ürünüyle birlikte
- Tuvalet, banyo, yüzme havuzları gibi ıslak hacimlerde,
- Yer altı ve yer üstü yapılarında, kanalizasyonlarda,
- Temellerde ve bodrum iç duvarlarında kullanılır.



VERPACKUNG / PACKAGING / AMBALAJ

5 Kg.

In Metall-/ Kunststoffeimern
In Metal / Plastic Buckets
Metal / Plastik Kovalarda

TECHNISCHE SPEZIFIKATIONEN / TECHNICAL SPECIFICATIONS / TEKNİK ÖZELLİKLERİ

Farbe / Colour / Renk	Grau / Grey / Gri
Partikelgröße / Particle Size / Partikül Boyutu	0 - 0,5 mm
Stückgewicht des Trockenmörtels / Dry Mortar Unit Weight / Kuru Harç Birim Ağırlığı	1200±100 kg/m ³
Hafffestigkeit nach Heißalterung / Adhesion strength after hot aging / Sıcakta yaşlandırma sonrası yapışma dayanımı	≥ 0,1 N/mm ²
Zeit einstellen / Setting Time / Priz Süresi	40 - 90 sn.



KRK BAUSTOFFE

"Geheimnis der Meister"

KRK-GROUT

- Fugenmörtel mit hoher Stabilität (5-50 mm)
- High Stability Grout Mortar (5-50 mm)
- Yüksek Stabiliteli Grout Harcı (5-50 mm)

 Es handelt sich um einen nicht schwindenden, selbstverdichtenden Vergussmörtel auf Zementbasis, der eine hohe Fließfähigkeit und Festigkeit bietet, ein spezielles granulometrisches Design hat und sich gegen den Schrumpfeffekt des Zements ausdehnt.

TS EN 1504-3 R4 Klasse

Öffentliche Arbeiten Artikel-Nr.: 04.613/3-C

EINSATZBEREICHE:

- Bei der Herstellung von Vorhang- und Säulenträumen,
- Bei der Kombination von Betonfertigteilen,
- Kompressoren, Pumpen und Generatoren reparieren,
- Beim Füllen der Lücken zwischen den Verankerungen,
- Als Füllmörtel in Maschinenfundamenten,
- Bei der Befestigung der Stützplatten,
- Bei der Befestigung der Stahlstützen am Fundament,
- In Schienenbetten,
- Füllen von Rissen, Spalten und Hohlräumen,

 It is a cement-based, non-shrinking, self-compacting grout mortar that provides high fluidity and strength, has a special granulometric design, expands against the shrinkage effect of the cement.

TS EN 1504-3 R4 Class

Public Works Item No: 04.613/3-C

USAGE AREAS:

- In the manufacture of curtain and column spaces,
- In the combination of prefabricated concrete building elements,
- Fixing the compressors, pumps and generators,
- Filling the gaps between the anchorages,
- As filling mortar in machine foundations,
- In fixing the support plates,
- In fixing the steel columns to the foundation,
- In rail beds,
- Filling cracks, gaps and cavities,

 Çimento esaslı, yüksek akışkanlık ve mukavemet sağlayan, özel granulometrik tasarıma sahip, çimentonun rötre etkisine karşılık genişleme özelliği olan büzülme yapmayan kendinden yerleşen grout harcıdır.

TS EN 1504-3 R4 Sınıfı

Bayındırlık Poz No: 04.613/3-C



VERPACKUNG / PACKAGING / AMBALAJ 25 Kg.

Kraftbeutel / Kraft Bag / Kraft Torba

KULLANIM ALANLARI:

- Perde ve kolon boşluklarının imalatında, • Prefabrik beton yapı elemanlarının birleşiminde, • Kompresör, pompa ve jeneratörlerin sabitlenmesinde, • Ankraj aralarındaki boşlukların doldurulmasında, • Makine temellerinde dolgu harcı olarak, • Mesnet plakalarının sabitlenmesinde, • Çelik kolonların temele sabitlenmesinde, • Ray yataklarında, • Çatlaklar, boşluklar ve oyukların doldurulmasında,

TECHNISCHE SPEZIFIKATIONEN / TECHNICAL SPECIFICATIONS / TEKNİK ÖZELLİKLERİ

25kg. Wasserverhältnis für Paket / 25 kg. Water Ratio for Package / 25 Kg. Paket için Su Oranı	< 4 litre
Druckfestigkeit / Compressive Strength / Basınç Dayanımı	>30 N/mm ² (1. tag/day/gün) >50 N/mm ² (7. tag/day/gün) >60 N/mm ² (28. tag/day/gün)
Haftkraft / Adhesion Strength / Yapışma Dayanımı	Beton/Concrete >2N/mm ² (28. tag/day/gün) Stahl/Steel/Çelik >2N/mm ² (28. gün)
Biegefestigkeit / Flexural Strength / Eğilme Dayanımı	>7N/mm ² (28. gün)
Auftragsstärke / Application Thickness / Uygulama Kalınlığı	10 - 50 mm

KRK-EPOXY

- Zweikomponenten-Betonklebstoff auf Epoxidbasis
- Epoxy Based Two Component Concrete Adhesive
- Epoxy Esaslı İki Bileşenli Beton Yapıştırıcısı

 Lösemittelfreier Mehrzweckklebstoff auf Epoxidbasis, der auch in feuchten Umgebungen aufgetragen und auf horizontalen und vertikalen Flächen verwendet werden kann. und Reparaturkosten.

EINSATZBEREICHE:

- Verkleben von Keramik, Fliesen, Granit, einigen Kunststoffen (PVC-Derivate) und ähnlichen Baustoffen auf Metall, Beton, Stahl, Holz, Marmor, Travertin und ähnlichen Oberflächen,
- Es wird verwendet, um Metall, Beton, Stahl, Holz, Marmor, Travertin und ähnliche Baustoffe miteinander zu verkleben.

 Solvent-free epoxy-based, multi-purpose adhesive that can be applied even in humid environments and can be used on horizontal and vertical surfaces. and repair cost.

USAGE AREAS:

- Bonding ceramic, tile, granite, some plastics (PVC derivatives) and similar building materials on metal, concrete, steel, wood, marble, travertine and similar surfaces,
- It is used for bonding metal, concrete, steel, wood, marble, travertine and similar building materials to each other.

 Solventsiz epoksi esaslı, rutubetli ortamlarda dahi uygulanabilen, yatay dikey yüzeylerde kullanılabilen çok amaçlı yapııştırma ve tamir onarım harcıdır.

KULLANIM ALANLARI:

- Metal, beton, çelik, ahşap, mermer, traverten ve benzeri yüzeyler üzerine seramik, fayans, granit, bazı plastikler (PVC türevleri) ve benzeri yapı malzemelerinin yapıştırılmasında,
- Metal, beton, çelik, ahşap, mermer, traverten ve benzeri yapı malzemelerinin birbirlerine yapıştırılmasında kullanılır.



VERPACKUNG / PACKAGING / AMBALAJ
A/B: 5+2,5 = 7,5 Kg Set

TECHNISCHE SPEZIFIKATIONEN / TECHNICAL SPECIFICATIONS / TEKNİK ÖZELLİKLERİ

Anzahl der Komponenten / Number of Components / Komponent Sayısı	2
Intensität / Intensity / Yoğunluk	1,55±0,05 gr/cm ³ 20°C TS EN ISO 2811-1
Ufer D / Shore D	80- ASTM D 2240, DIN 53505
Mischverhältnis / Mixing ratio / Karışım Oranı	nach Gewicht / by weight / Ağırlıkça A/B: 50/50
Gemischlebensdauer / Mixture Life / Karışım Ömrü	50-60 Min./Dk. /23 °C, 200 g. DIN 16945
Trockenzeit / Drying Time / Kuruma Süresi	Pulvertrocknung/Powder Drying/Toz Kuruma: 4-5 Stunde/Hour/Saat 23°C TS 4317 Berühren Sie Trocken/Touch Dry/Dokunma Kurumasi: 6-8 Stunde/Hour/Saat 23°C TS 4317
Kondensation / Condensation / Yoğuşma	Volltrocken/Full Dry/Tam Kuruma: 7 tag/day/gün 23°C TS 4317 Der Feuchtigkeitsgehalt der Oberfläche sollte max. 6-7% betragen. Moisture rate on the surface should be 6-7% max. Yüzeydeki nem oranı max.%6-7 oranında olmalıdır.

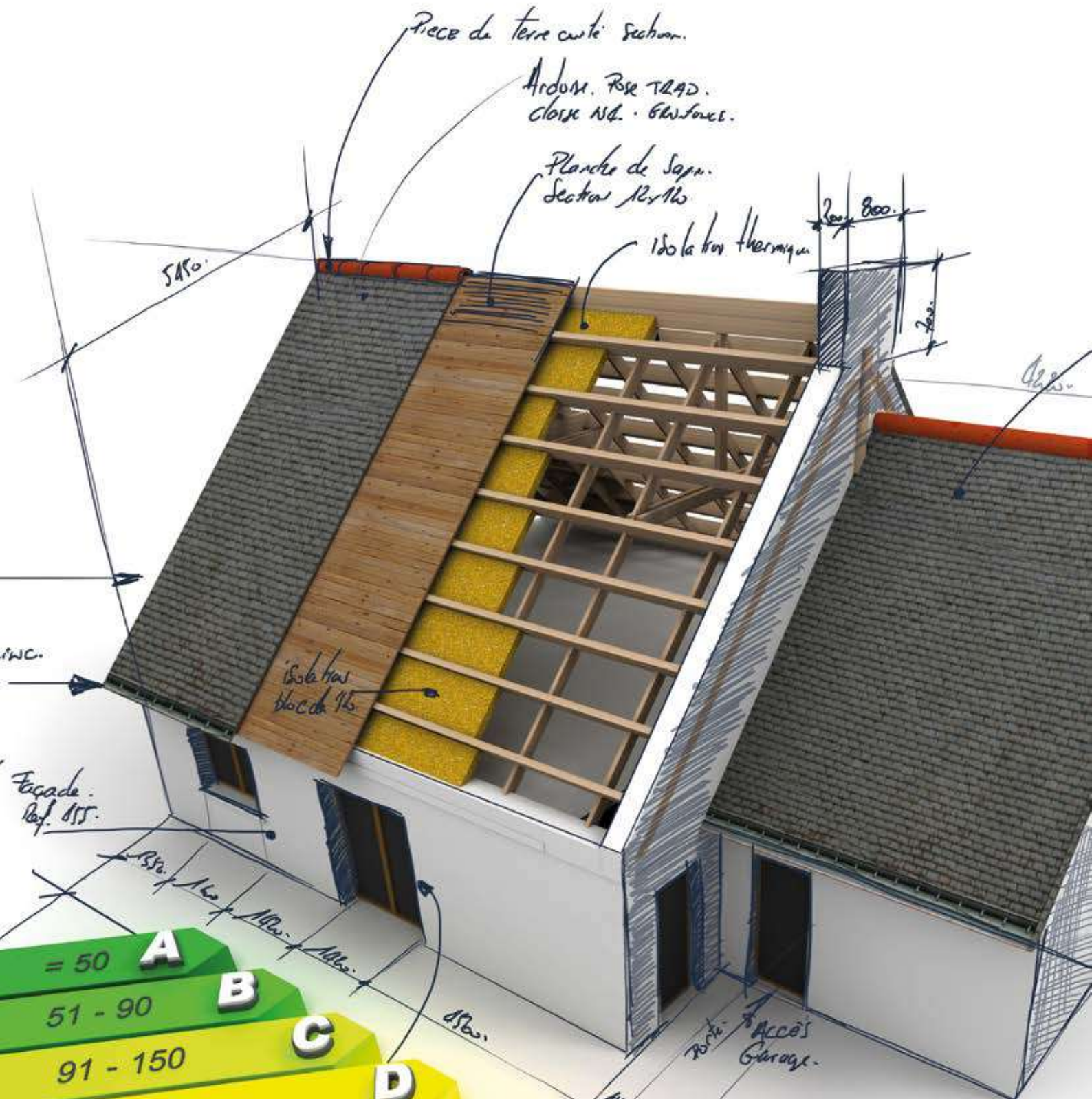

Produkte zur
 Wärmedämmung

Thermal Insulation
 Products

Isı Yalıtım
 Ürünleri

KRK BAUSTOFFE

"Geheimnis der Meister"

THERMKLEBER

· Thermal Insulation System Adhesive
· Isı Yalıtım Sistemi Yapıştırıcısı

 Es ist ein extrem fester Klebemörtel auf Zementbasis mit Polymerzusätzen, der für die Verklebung von Wärmedämmplatten entwickelt wurde.

EINSATZBEREICHE:

• Es dient zur Verklebung von Wärmedämmplatten wie XPS, EPS, Steinwolle und Steinwolle an Innen- und Außenfassaden.

 It is an extremely strong cement-based adhesive mortar containing polymer additives, developed for the bonding of thermal insulation boards.

USAGE AREAS:

• It is used for bonding thermal insulation boards such as XPS, EPS, rock wool and rock wool on interior and exterior facades.

 Isı yalıtım levhalarının yapıştırılması için geliştirilmiş, polimer katkıları ihtiva eden son derece güçlü çimento esaslı yapıştırma harcıdır.

KULLANIM ALANLARI:

• İç ve dış cephelerde XPS, EPS, taş yünü ve kaya yünü gibi ısı yalıtım levhalarının yapıştırılmasında kullanılır.



VERPACKUNG / PACKAGING / AMBALAJ

25 Kg.

Kraftbeutel / Kraft Bag / Kraft Torba

TECHNISCHE SPEZIFIKATIONEN / TECHNICAL SPECIFICATIONS / TEKNİK ÖZELLİKLERİ

Anwendungstemperatur / Application temperature / Uygulama sıcaklığı	(+5°C)-(+30°C)
Verputzzeit nach der Verklebung / Time required for plastering after bonding / Yapıştırma sonrası sıva için gerekli süre	24 Stunde/Hour/Saat
Druckfestigkeit / compressive strength / Basınç dayanımı	>6 N/mm ² (28 Tage später/days later/ gün sonra)
Biegefestigkeit / bending strength / Eğilme dayanımı	>2 N/mm ² (28 Tage später/days later/ gün sonra)
Haftfestigkeit auf Untergrund / Adhesion strength to substrate / Alt tabakaya yapışma dayanımı	>0,5 N/mm ² (28 Tage später/days later/ gün sonra)
Haftfestigkeit auf Wärmedämmplatte / Adhesion strength to heat insulation board / Isı yalıtım levhasına yapışma dayanımı	>0,08 N/mm ² (28 Tage später/days later/ gün sonra)
Wasseraufnahme / water absorption / Su emme	≤ 5 g (30 Minuten später/minutes later/ dakika sonra) ≤ 10g (240 Minuten später/minutes later/ dakika sonra)
Reaktion auf Feuer / Reaction to fire / Yangına tepki	A1

THERMMORTAR

• Thermal Insulation System Plaster
• Isı Yalıtım Sistemi Sıvası



Es handelt sich um einen äußerst haltbaren und leicht zu verarbeitenden, polymerhaltigen Putzmörtel, der zur Bildung von Dünnenschichtputzen auf gebrauchsfertigen Wärmedämmplatten vorbereitet ist.

EINSATZBEREICHE:

• Es wird zum Verputzen von Wärmedämmplatten wie XPS, EPS, Steinwolle und Steinwolle an Innen- und Außenfassaden verwendet.



It is an extremely durable and easy-to-apply plaster mortar containing polymer, prepared to form thin layer plaster on ready-to-use thermal insulation boards.

USAGE AREAS:

• It is used for plastering thermal insulation boards such as XPS, EPS, rock wool and rock wool on interior and exterior facades.



Kullanıma hazır ısı yalıtım levhalarının üzerinde ince tabaka sıva oluşturmak amacı ile hazırlanmış, polimer ihtiva eden, son derece dayanıklı ve kolay uygulanan sıva harcıdır.

KULLANIM ALANLARI:

• İç ve dış cephelerde XPS, EPS, taş yünü ve kaya yünü gibi ısı yalıtım levhalarının sıvanmasında kullanılır.



VERPACKUNG / PACKAGING / AMBALAJ

25 Kg.

Kraftbeutel / Kraft Bag / Kraft Torba

TECHNISCHE SPEZIFIKATIONEN / TECHNICAL SPECIFICATIONS / TEKNİK ÖZELLİKLERİ

Anwendungstemperatur / Application temperature / Uygulama sıcaklığı	(+5°C)-(+30°C)
Auftragsstärke / Application Thickness / Uygulama Kalınlığı	3-4 mm
Topfzeit / Pot Life / Kap Ömrü	2 Stunde/Hour/Saat
Zeit zwischen den Mänteln zu warten / Time to wait between coats / Katlar arası beklenmesi gereken süre	4-5 Stunde/Hour/Saat
Trockene Schüttdichte / Dry Bulk Density / Kuru Yığın Yoğunluğu	1400±300 kg/m ³
Druckfestigkeit / compressive strength / Basınç dayanımı	>6 N/mm ² (28 Tage später/days later/gün sonra)
Haftfestigkeit / Bond strength / Bağ dayanımı	≥ 0,5 N/mm ² FP(A) (28 Tage später/days later/gün sonra)
Kapillare Wasseraufnahme / Capillary water absorption / Kapiler su emme	W0
Wärmeleitfähigkeit / thermal conductivity / Isıl iletkenlik	(λ10, trocken/dry/kuru) 0,75 W/m.K P=%50
Wasserdampfdurchlässigkeitskoeffizient / Water vapor permeability coefficient / Su buharı geçirgenliği katsayısı	≤15 μ
Reaktion auf Feuer / Reaction to fire / Yangına tepki	A1

- Bu değerler +23±2 °C sıcaklık ve %50±5 bağıl nemli ortam koşulları için verilmiştir.



KRK BAUSTOFFE

"Geheimnis der Meister"

THERMHARD

• Thermal Insulation System Decorative Coating
• Isı Yalıtım Sistemi Dekoratif Kaplaması

 Es handelt sich um eine auf Weißzement basierende, einkomponentige, polymer- und faserverstärkte, mineralisch strukturierte, wasserabweisende dekorative Fassadenbeschichtung, die mit einer Kelle aufgetragen wird.

EINSATZBEREICHE:

• Es wird in dekorativen Beschichtungsanwendungen als Ergänzung zu Wärmedämmsystemen auf fachgerecht ausgeführten Rauputzen, Feinputzen, Sichtbeton, Gasbeton und selbsttragenden Altlackoberflächen auf Acrylbasis verwendet.

 It is a white cement based, single component, polymer and fiber added, mineral textured top coat water repellent decorative facade coating applied with a trowel.

USAGE AREAS:

• It is used in decorative coating application as a complement to thermal insulation systems on properly made rough plaster, fine plaster, exposed concrete, gas concrete and self-supporting acrylic-based old painted surfaces.

 Beyaz çimento esaslı, tek bileşenli, polimer ve elyaf katkılı, mala ile uygulanan, mineral dokulu son kat su itici dekoratif cephe kaplamasıdır.

KULLANIM ALANLARI:

• İç ve dış cephelerde, düzgün yapılmış kaba sıva, ince sıva, brüt beton, gaz beton ve kendini taşıyabilecek akrilik esaslı eski boyalı yüzeylerde ısı yalıtım sistemlerinin tamamlayıcısı olarak dekoratif kaplama uygulamasında kullanılır.



VERPACKUNG / PACKAGING / AMBALAJ

25 Kg.

Kraftbeutel / Kraft Bag / Kraft Torba

TECHNISCHE SPEZIFIKATIONEN / TECHNICAL SPECIFICATIONS / TEKNİK ÖZELLİKLERİ

Farbe / Colour / Renk	Weiß / White / Beyaz
Haftfestigkeit (auf mineralischer Oberfläche) / Adhesion Strength (On Mineral Surface) / Yapışma Dayanımı (Mineral Yüzey Üzerine)	≥ 0,5 N/mm ²
Druckfestigkeit / Compressive Strength / Basınç Dayanımı	≥ 10 N/mm ²
Biegefestigkeit / Flexural Strength / Eğilme Dayanımı	≥ 4 N/mm ²
Kömung / Grain Size / Tane büyüklüğü	> max. 2 mm

- Bu değerler +23±2 °C sıcaklık ve %50±5 bağıl nemli ortam koşulları için verilmiştir.

THERMKLEBER PLUS

- Thermal Insulation System Adhesive
- Isı Yalıtım Sistemi Yapıştırıcısı

 Es ist ein extrem fester Klebemörtel auf Zementbasis mit Polymerzusätzen, der für die Verklebung von Wärmedämmplatten entwickelt wurde.

EINSATZBEREICHE:

- Es dient zur Verklebung von Wärmedämmplatten wie XPS, EPS, Steinwolle und Steinwolle an Innen- und Außenfassaden.

 It is an extremely strong cement-based adhesive mortar containing polymer additives, developed for the bonding of thermal insulation boards.

USAGE AREAS:

- It is used for bonding thermal insulation boards such as XPS, EPS, rock wool and rock wool on interior and exterior facades.

 Isı yalıtım levhalarının yapıştırılması için geliştirilmiş, polimer katkıları ihtiva eden son derece güçlü çimento esaslı yapıştırma harcıdır.

KULLANIM ALANLARI:

- İç ve dış cephelerde XPS, EPS, taş yünü ve kaya yünü gibi ısı yalıtım levhalarının yapıştırılmasında kullanılır.



VERPACKUNG / PACKAGING / AMBALAJ

25 Kg.

Kraftbeutel / Kraft Bag / Kraft Torba

TECHNISCHE SPEZIFIKATIONEN / TECHNICAL SPECIFICATIONS / TEKNİK ÖZELLİKLERİ

Anwendungstemperatur / Application temperature / Uygulama sıcaklığı	(+5°C)-(+30°C)
Verputzzeit nach der Verklebung / Time required for plastering after bonding / Yapıştırma sonrası sıva için gerekli süre	24 Stunde/Hour/Saat
Druckfestigkeit / compressive strength / Basınç dayanımı	>6 N/mm ² (28 Tage später/days later/ gün sonra)
Biegefestigkeit / bending strength / Eğilme dayanımı	>2 N/mm ² (28 Tage später/days later/ gün sonra)
Haftfestigkeit auf Untergrund / Adhesion strength to substrate / Alt tabakaya yapışma dayanımı	>0,5 N/mm ² (28 Tage später/days later/ gün sonra)
Haftfestigkeit auf Wärmedämmplatte / Adhesion strength to heat insulation board / Isı yalıtım levhasına yapışma dayanımı	>0,08 N/mm ² (28 Tage später/days later/ gün sonra)
Wasseraufnahme / water absorption / Su emme	≤ 5 g (30 Minuten später/minutes later/ dakika sonra) ≤ 10g (240 Minuten später/minutes later/ dakika sonra)
Reaktion auf Feuer / Reaction to fire / Yangına tepki	A1



KRK BAUSTOFFE

"Geheimnis der Meister"

THERMMORTAR PLUS

· Thermal Insulation System Plaster
· Isı Yalıtım Sistemi Sıvası



Es handelt sich um einen äußerst haltbaren und leicht zu verarbeitenden, polymerhaltigen Putzmörtel, der zur Bildung von Dünnenschichtputzen auf gebrauchsfertigen Wärmedämmplatten vorbereitet ist.

EINSATZBEREICHE:

• Es wird zum Verputzen von Wärmedämmplatten wie XPS, EPS, Steinwolle und Steinwolle an Innen- und Außenfassaden verwendet.



It is an extremely durable and easy-to-apply plaster mortar containing polymer, prepared to form thin layer plaster on ready-to-use thermal insulation boards.

USAGE AREAS:

• It is used for plastering thermal insulation boards such as XPS, EPS, rock wool and rock wool on interior and exterior facades.



Kullanıma hazır ısı yalıtım levhalarının üzerinde ince tabaka sıva oluşturmak amacı ile hazırlanmış, polimer ihtiva eden, son derece dayanıklı ve kolay uygulanan sıva harcıdır.

KULLANIM ALANLARI:

• İç ve dış cephelerde XPS, EPS, taş yünü ve kaya yünü gibi ısı yalıtım levhalarının sıvanmasında kullanılır.



VERPACKUNG / PACKAGING / AMBALAJ

25 Kg.

Kraftbeutel / Kraft Bag / Kraft Torba

TECHNISCHE SPEZIFIKATIONEN / TECHNICAL SPECIFICATIONS / TEKNİK ÖZELLİKLERİ

Anwendungstemperatur / Application temperature / Uygulama sıcaklığı	(+5°C)-(+30°C)
Auftragsstärke / Application Thickness / Uygulama Kalınlığı	3-4 mm
Topfzeit / Pot Life / Kap Ömrü	2 Stunde/Hour/Saat
Zeit zwischen den Mänteln zu warten / Time to wait between coats / Katlar arası beklenmesi gereken süre	4-5 Stunde/Hour/Saat
Trockene Schüttdichte / Dry Bulk Density / Kuru Yığın Yoğunluğu	1400±300 kg/m ³
Druckfestigkeit / compressive strength / Basınç dayanımı	>6 N/mm ² (28 Tage später/days later/gün sonra)
Haftfestigkeit / Bond strength / Bağ dayanımı	≥ 0,5 N/mm ² FP(A) (28 Tage später/days later/gün sonra)
Kapillare Wasseraufnahme / Capillary water absorption / Kapiler su emme	W0
Wärmeleitfähigkeit / thermal conductivity / Isıl iletkenlik	(λ10, trocken/dry/kuru) 0,75 W/m.K P=%50
Wasserdampfdurchlässigkeitskoeffizient / Water vapor permeability coefficient / Su buharı geçirgenliği katsayısı	≤15 μ
Reaktion auf Feuer / Reaction to fire / Yangına tepki	A1

- Bu değerler +23±2 °C sıcaklık ve %50±5 bağıl nemli ortam koşulları için verilmiştir.

THERMHARD PLUS

· Thermal Insulation System Decorative Coating
· Isı Yalıtım Sistemi Dekoratif Kaplaması

 Es handelt sich um eine auf Weißzement basierende, einkomponentige, polymer- und faserverstärkte, mineralisch strukturierte, wasserabweisende dekorative Fassadenbeschichtung, die mit einer Kelle aufgetragen wird.

EINSATZBEREICHE:

• Es wird in dekorativen Beschichtungsanwendungen als Ergänzung zu Wärmedämmsystemen auf fachgerecht ausgeführten Rauputzen, Feinputzen, Sichtbeton, Gasbeton und selbsttragenden Altlackoberflächen auf Acrylbasis verwendet.

 It is a white cement based, single component, polymer and fiber added, mineral textured top coat water repellent decorative facade coating applied with a trowel.

USAGE AREAS:

• It is used in decorative coating application as a complement to thermal insulation systems on properly made rough plaster, fine plaster, exposed concrete, gas concrete and self-supporting acrylic-based old painted surfaces.

 Beyaz çimento esaslı, tek bileşenli, polimer ve elyaf katkılı, mala ile uygulanan, mineral dokulu son kat su itici dekoratif cephe kaplamasıdır.

KULLANIM ALANLARI:

• İç ve dış cephelerde, düzgün yapılmış kaba sıva, ince sıva, brüt beton, gaz beton ve kendini taşıyabilecek akrilik esaslı eski boyalı yüzeylerde ısı yalıtım sistemlerinin tamamlayıcısı olarak dekoratif kaplama uygulamasında kullanılır.



VERPACKUNG / PACKAGING / AMBALAJ

25 Kg.

Kraftbeutel / Kraft Bag / Kraft Torba

TECHNISCHE SPEZIFIKATIONEN / TECHNICAL SPECIFICATIONS / TEKNİK ÖZELLİKLERİ

Farbe / Colour / Renk	Weiß / White / Beyaz
Haftfestigkeit (auf mineralischer Oberfläche) / Adhesion Strength (On Mineral Surface) / Yapışma Dayanımı (Mineral Yüzey Üzerine)	≥ 0,5 N/mm ²
Druckfestigkeit / Compressive Strength / Basınç Dayanımı	≥ 10 N/mm ²
Biegefestigkeit / Flexural Strength / Eğilme Dayanımı	≥ 4 N/mm ²
Kömung / Grain Size / Tane büyüklüğü	> max. 2 mm

- Bu değerler +23±2 °C sıcaklık ve %50±5 bağıl nemli ortam koşulları için verilmiştir.

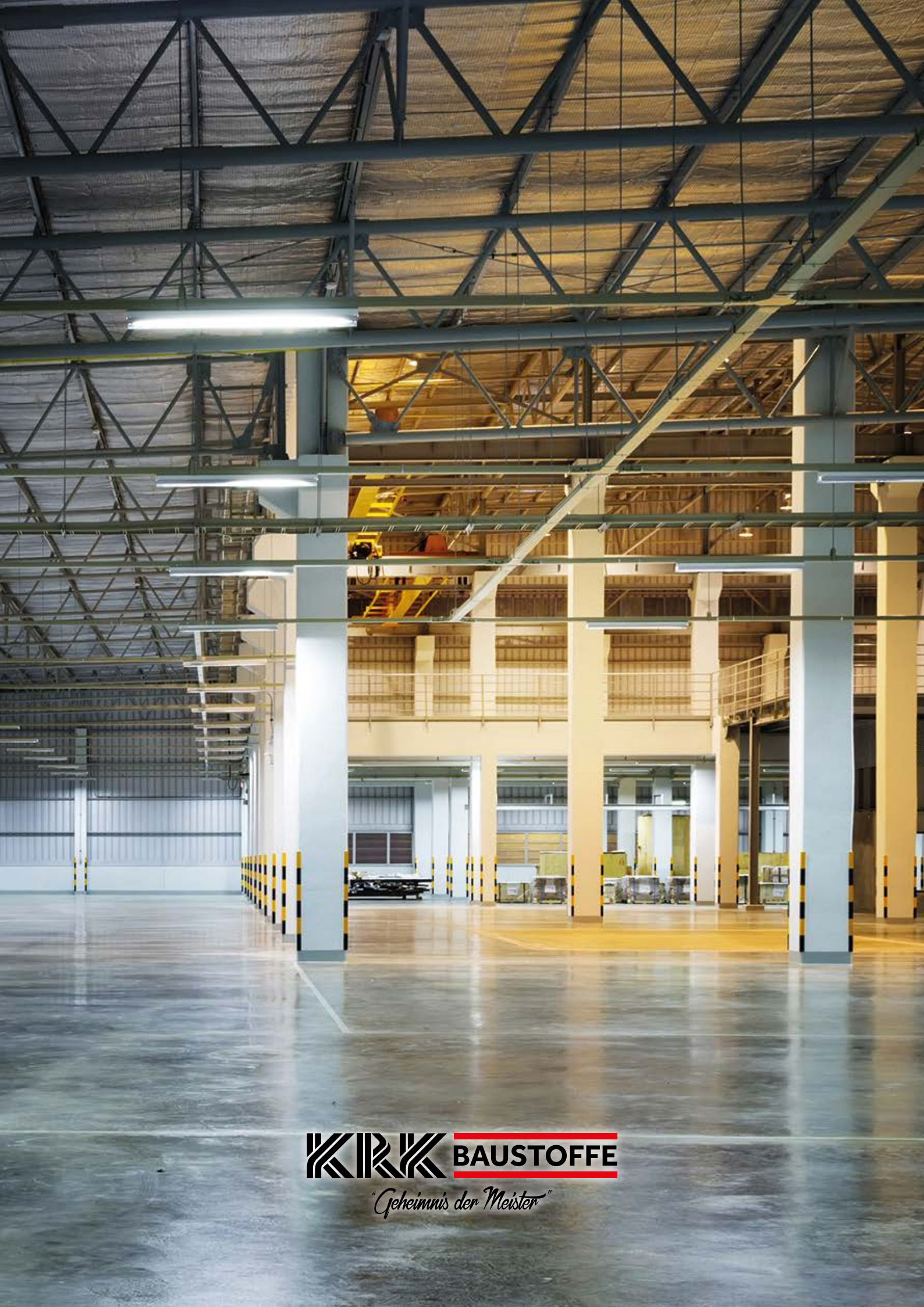

KRK BAUSTOFFE

"Geheimnis der Meister"

KRK-600

- Quarzzuschlag Oberflächenhärter
- Quartz Aggregate Surface Hardener
- Kuvars Agregalı Yüzey Sertleştirici



Es handelt sich um einen gebrauchsfertigen Betonoberflächenhärtemörtel, bestehend aus hydraulischem Bindemittel, Quarzzuschlag und chemischen Zusätzen, der durch Einstreuen in Pulverform aufgetragen wird und die Festigkeit und Abriebfestigkeit von Industriebodenoberflächen mit frisch poliertem Plattenbeton erhöht.

EINSATZBEREICHE:

- Drinnen und draußen,
- Lager-, Be- und Entladebereiche,
- Auf Fabrik- und Industriehallenböden,
- In Einkaufszentren, Messegeländen,
- Garage, Parkplätze und Tankstellen,
- In Hangars und mechanischen Werkstätten,
- Es wird in Schulen, Krankenhäusern, Wohnungen und Arbeitsplätzen verwendet.



It is a ready-to-use concrete surface hardening mortar, consisting of hydraulic binder, quartz aggregate and chemical additives, applied by sprinkling in powder form, increasing the strength and abrasion resistance of industrial floor surfaces with freshly polished slab concrete.

USAGE AREAS:

- Indoors and outdoors,
- In warehouse, loading and unloading areas,
- On factory and industrial plant floors,
- In shopping malls, fairgrounds,
- Garage, parking areas and service stations,
- In hangars and mechanical workshops,
- It is used in schools, hospitals, residences and workplaces.



Taze perdahlanmış döşeme betonu olan endüstriyel zemin yüzeylerinin mukavemet ve aşınma direncini yükselten, toz halde serpilerek uygulanan, hidrolik bağlayıcı, kuvars agregası ve kimyasal katkılarından oluşan, kullanıma hazır beton yüzey sertleştirme harcıdır.

KULLANIM ALANLARI:

- İç ve dış mekânlarda, • Depo, yükleme ve boşaltma alanlarında, • Fabrika ve endüstriyel tesis zeminlerinde, • Alışveriş merkezlerinde, fuar alanlarında, • Garaj, otopark alanları ve servis istasyonları, • Hangarlar ve mekanik atölyelerde, • Okul, hastane, konut ve işyerlerinde kullanılır.



VERPACKUNG / PACKAGING / AMBALAJ

25 Kg.

Kraftbeutel / Kraft Bag / Kraft Torba

TECHNISCHE SPEZIFIKATIONEN / TECHNICAL SPECIFICATIONS / TEKNİK ÖZELLİKLERİ

Materialstruktur / Material Structure / Malzeme Yapısı	Spezieller Zement- und Quarzzuschlag / Special Cement and Quartz Aggregate / Özel Çimento ve Kuvars Agregası
Druckfestigkeit / Compressive Strength / Basınç Mukavemeti	> 0,70 N/mm ² (28 Tage später/days later/gün sonra)
Abriebfestigkeit-Böhme-Methode / Abrasion Resistance-Böhme Method / Aşınma Dayanımı-Böhme Metodu	3,5 cm ³ /50 cm ²
Korngröße: max. 3 mm Auftragsstärke / Grain Size: max. 3 mm Application Thickness / Tane Boyutu: max. 3 mm Uygulama Kalınlığı	2-4 mm: Farbe: Naturgrau, Rot, Grün / Color: Natural grey, Red, Green / Renk: Natural gri, Kırmızı, Yeşil
Begehbare Zeit / Walkable time / Üzerinde yürünebilme süresi	1 Tag nach der Anwendung/1 day after application/Uygulamadan 1 gün sonra
Reaktion auf Feuer / Reaction to fire / Yangına tepki	A1

- Bu değerler +23±2 °C sıcaklık ve %50±5 bağıl nemli ortam koşulları için verilmiştir.

KRK-610

- Korund Oberflächenhärter
- Corundum Aggregate Surface Hardener
- Korund Agregalı Yüzey Sertleştirici



Es handelt sich um einen gebrauchsfertigen Betonoberflächenhärtemörtel, bestehend aus hydraulischem Bindemittel, Korundzuschlag und chemischen Zuschlagstoffen, der durch Einstreuen in Pulverform aufgetragen wird und die Festigkeit und Abriebfestigkeit von Industriebodenoberflächen mit frisch poliertem Plattenbeton erhöht.

EINSATZBEREICHE:

- Drinnen und draußen,
- Lager-, Be- und Entladebereiche,
- Auf Fabrik- und Industriehallenböden,
- In Einkaufszentren, Messegeländen,
- Garage, Parkplätze und Tankstellen,
- In Hangars und mechanischen Werkstätten,
- Es wird in Schulen, Krankenhäusern, Wohnungen und Arbeitsplätzen verwendet.



It is a ready-to-use concrete surface hardening mortar, consisting of hydraulic binder, corundum aggregate and chemical additives, applied by sprinkling in powder form, increasing the strength and abrasion resistance of industrial floor surfaces with freshly polished slab concrete.

USAGE AREAS:

- Indoors and outdoors,
- In warehouse, loading and unloading areas,
- On factory and industrial plant floors,
- In shopping malls, fairgrounds,
- Garage, parking areas and service stations,
- In hangars and mechanical workshops,
- It is used in schools, hospitals, residences and workplaces.



Taze perdahlanmış döşeme betonu olan endüstriyel zemin yüzeylerinin mukavemet ve aşınma direncini yükselten, toz halde serpilerek uygulanan, hidrolik bağlayıcı, korund agregası ve kimyasal katkılardan oluşan, kullanıma hazır beton yüzey sertleştirme harcıdır.

KULLANIM ALANLARI:

- İç ve dış mekânlarda, • Depo, yükleme ve boşaltma alanlarında, • Fabrika ve endüstriyel tesis zeminlerde, • Alışveriş merkezlerinde, fuar alanlarında, • Garaj, otopark alanları ve servis istasyonları, • Hangarlar ve mekanik atölyelerde, • Okul, hastane, konut ve işyerlerinde kullanılır.



VERPACKUNG / PACKAGING / AMBALAJ

25 Kg.

Kraftbeutel / Kraft Bag / Kraft Torba

TECHNISCHE SPEZIFIKATIONEN / TECHNICAL SPECIFICATIONS / TEKNİK ÖZELLİKLERİ

Materialstruktur / Material Structure / Malzeme Yapısı	Spezieller Zement- und Quarzzuschlag / Special Cement and Quartz Aggregate / Özel Çimento ve Kuvars Agregası
Druckfestigkeit / Compressive Strength / Basınç Mukavemeti	> 0,70 N/mm ² (28 Tage später/days later/gün sonra)
Abriebfestigkeit-Böhme-Methode / Abrasion Resistance-Böhme Method / Aşınma Dayanımı-Böhme Metodu	2,5 cm ³ /50 cm ²
Korngröße: max. 3 mm Auftragsstärke / Grain Size: max. 3 mm Application Thickness / Tane Boyutu: max. 3 mm Uygulama Kalınlığı	2-4 mm: Farbe: Naturgrau, Rot, Grün / Color: Natural grey, Red, Green / Renk: Natural gri, Kırmızı, Yeşil
Begehbare Zeit / Walkable time / Üzerinde yürünebilme süresi	1 Tag nach der Anwendung/1 day after application/Uygulamadan 1 gün sonra
Reaktion auf Feuer / Reaction to fire / Yangına tepki	A1

- Bu değerler +23±2 °C sıcaklık ve %50±5 bağıl nemli ortam koşulları için verilmiştir.



Klebstoffgruppe

Adhesive
Group

Yapıştırıcı
Grubu

KRK BAUSTOFFE

"Geheimnis der Meister"

KRK-A402

- Glasziegelkleber
- Glass Brick Adhesive
- Cam Tuğla Yapıştırıcısı

 Es handelt sich um ein aus Aragonit-Metall hergestelltes Klebematerial mit einem sehr hohen Weißgrad, das zum dekorativen Erscheinungsbild beiträgt, indem es sich optimal an die Struktur des Glases anpasst. Es bietet eine glatte Oberfläche.

EINSATZBEREICHE:

- Es wird in allen Arten von Innen- und Außenbereichen verwendet, an denen Glassteine verwendet werden.
- Rutschfest, einfach zu bedienen.
- Erfordert keine gemeinsame Anwendung.

 It is an adhesive material produced from Aragonite metal with a very high whiteness degree, which contributes to the decorative appearance by adapting to the structure of the glass in the most perfect way. It provides a smooth surface.

USAGE AREAS:

- It is used in all kinds of interior and exterior places where glass brick is applied.
- Non-slip, easy to use.
- Does not require joint application.

 Camın yapısına en mükemmel şekilde uyum sağlayarak, dekoratif görünümüne katkıda bulunan, beyazlık derecesi çok yüksek Aragonit madeninden üretilmiş yapıştırıcı malzemedir. Pürüzsüz bir yüzey elde edilmesini sağlar.

KULLANIM ALANLARI:

- Cam tuğla uygulamasının yapıldığı her türlü iç ve dış mekânda kullanılır.
- Kayma yapmaz, kullanımı kolaydır.
- Derz uygulaması gerektirmez.



VERPACKUNG / PACKAGING / AMBALAJ

19 Kg.

Kraftbeutel / Kraft Bag / Kraft Torba

TECHNISCHE SPEZIFIKATIONEN / TECHNICAL SPECIFICATIONS / TEKNİK ÖZELLİKLERİ

Farbe / Colour / Renk	Weiß / White / Beyaz
Mischverhältnis / Mixing ratio / Karışım Oranı	19 kg Produkt werden mit durchschnittlich 4,0-4,5 Liter Wasser gemischt / 19 kg product is mixed with an average of 4.0-4.5 liters of water / 19 kg.lık ürün ortalama 4,0-4,5 lt su ile karıştırılır.
Verbrauch / Consumption / Tüketim	1 m ² Durchschnitt / average / ortalama 7,5 - 8,5 kg.
Topfzeit / Pot Life / Kap Ömrü	1 Stunde/Hour/Saat
Reifezeit / Maturation Time / Olgunlaşma Süresi	5 Minute / Dakika



KRK-A404

- Porenbeton-Verlegemörtel
- Aerated Concrete Laying Mortar
- Gazbeton Örgü Harcı

 Es ist ein Mauermörtel, der in Mauerwerksmaterialien wie Gasbeton verwendet wird.

EINSATZBEREICHE:

- Es wird bei Gasbeton-Mauerarbeiten im Innen- und Außenbereich eingesetzt.
- Rutschfest, einfach zu bedienen.

 It is a masonry mortar used in masonry materials such as gas concrete.

USAGE AREAS:

- It is used in gas concrete walling works indoors and outdoors.
- Non-slip, easy to use.

 Gaz beton gibi duvar örgü malzemelerinde kullanılan örgü harcıdır.

KULLANIM ALANLARI:

- İç ve dış mekânlarda gaz beton duvar örme işlerinde kullanılır.
- Kayma yapmaz, kullanımı kolaydır.



VERPACKUNG / PACKAGING / AMBALAJ

25 Kg.

Kraftbeutel / Kraft Bag / Kraft Torba

TECHNISCHE SPEZIFIKATIONEN / TECHNICAL SPECIFICATIONS / TEKNİK ÖZELLİKLERİ

Farbe / Colour / Renk	Grau weiß / Grey-White / Gri-Beyaz
Mischverhältnis / Mixing ratio / Karışım Oranı	25 kg Produkt werden mit durchschnittlich 6-7 Liter Wasser gemischt / 25 kg product is mixed with an average of 6-7 liters of water / 25 kg.lık ürün ortalama 6-7 lt su ile karıştırılır.
Verbrauch / Consumption / Tüketim	1,7 kg für einen durchschnittlichen 10 cm Block. - 2,3 kg für einen 15 cm Block. - 3 kg für einen 20 cm Block. (Durchschnitt pro 1 m ²) (8x8 mm. Kammgröße) / 1,7 kg for an average 10 cm block. - 2.3 kg for a 15 cm block. - 3 kg for a 20 cm block. (average per 1 m ²) (8x8 mm. comb size) / Ortalama 10 cm.lik blok için 1,7 kg. - 15 cm.lik blok için 2,3 kg. - 20 cm.lik blok için 3 kg. (1 m ² için ortalama) (8x8 mm. tarak ölçüsünde)
Topfzeit / Pot Life / Kap Ömrü	2 Stunde/Hour/Saat
Reifezeit / Maturation Time / Olgunlaşma Süresi	5 Minute / Dakika



Fertigputzgruppe

Ready Plaster
Group

Hazır Sıva
Grubu

KRK BAUSTOFFE

"Geheimnis der Meister"

KRK-X40

- Handpflaster auf Zementbasis
- Cement Based Hand Plaster
- Çimento Esaslı El Sıvası

 Es ist ein zementbasierter Handputz, der auf Oberflächen wie Ziegel, Gasbeton, Bimsstein, Brikettwand an Innen- und Außenfassaden aufgetragen werden kann und eine Haftung und einfache Anwendung bietet.

EINSATZBEREICHE:

- Es bietet die Möglichkeit, sich leicht auf die Oberflächen von Mauerwerksmaterialien wie Ziegel, Gasbeton, Bimsstein aufzutragen.
- Es hat eine hohe Adhäsionsstabilität.
- Ein fertiges Produkt für Putzanwendungen zu haben spart Zeit und Arbeit.
- Es sorgt für härtere, glattere und widerstandsfähigere Oberflächen als alte Putze.
- Führt sowohl Grob- als auch Feinputzverfahren durch, indem eine einzige Schicht aufgetragen wird.

 It is a cement-based hand plaster that can be applied to surfaces such as brick, gas concrete, pumice, briquette wall on interior and exterior facades, providing adhesion and easy application.

USAGE AREAS:

- It provides the opportunity to easily apply on the surfaces of masonry materials such as brick, gas concrete, pumice.
- It has high adhesion stability.
- Having a ready-made product in plaster applications saves time and labor.
- It provides to obtain surfaces that are harder, smoother and more resistant to impacts than old plasters.
- Performs both rough and fine plastering processes by applying a single layer.

 İç ve dış cephelerde tuğla, gaz beton, bims, briket duvar gibi yüzeylere uygulanabilen yapışma ve rahat uygulama olanağı sağlayan çimento esaslı el sıvasıdır.

KULLANIM ALANLARI:

- Özellikle tuğla, gaz beton, bims gibi duvar örgü malzemelerinin yüzeylerine rahatlıkla uygulama olanağı sağlar.
- Yüksek yapışma stabilitesine sahiptir.
- Sıva uygulamalarında hazır bir ürün olması zaman ve işçilikten kazanılır.
- Eski sıvalara göre daha sert, düzgün ve darbelere karşı dayanıklı yüzeylerin elde edilmesini sağlar.
- Tek kat uygulama yaparak hem kaba hem de ince sıva işlemini görür.



VERPACKUNG / PACKAGING / AMBALAJ

25 Kg.

Kraftbeutel / Kraft Bag / Kraft Torba

TECHNISCHE SPEZIFIKATIONEN / TECHNICAL SPECIFICATIONS / TEKNİK ÖZELLİKLERİ

Farbe / Colour / Renk	Grau weiß / Grey-White / Gri-Beyaz
Mischverhältnis / Mixing ratio / Karışım Oranı	25 kg Produkt werden mit durchschnittlich 6-7 Liter Wasser gemischt / 25 kg product is mixed with an average of 6-7 liters of water / 25 kg.lık ürün ortalama 6-7 lt su ile karıştırılır.
Verbrauch / Consumption / Tüketim	16 -17 kg für 1 m ² / 16 -17 kg for 1 m ² / 1 m ² için 16 -17 kg.
Topfzeit / Pot Life / Kap Ömrü	2 Stunde/Hour/Saat
Reifezeit / Maturation Time / Olgunlaşma Süresi	5 Minute / Dakika

KRK-X50

- Zementbasierte Maschine und Handpflaster
- Cement Based Machine and Hand Plaster
- Çimento Esaslı Makine ve El Sıvası

 Es ist ein zementbasierter, modifizierter, polymerverstärkter Maschinen- und Handputz, der auf Oberflächen wie Ziegel, Gasbeton, Bimsstein, Brikettwand an Innen- und Außenfassaden aufgetragen werden kann und eine Haftung und einfache Anwendung bietet.

EINSATZBEREICHE:

- Es bietet die Möglichkeit des maschinellen Auftrags auf die Oberflächen von Mauerwerksmaterialien wie Ziegel, Porenbeton und Bimsstein.
- Es hat eine hohe Adhäsionsstabilität.
- Da es maschinell verarbeitet wird und es sich um ein fertiges Produkt handelt, werden Zeit und Arbeit gespart.
- Es sorgt für härtere, glattere und widerstandsfähigere Oberflächen als alte Putze.
- Führt sowohl Grob- als auch Feinputzverfahren durch, indem eine einzige Schicht aufgetragen wird.

 It is a cement-based, modified polymer-added machine and hand plaster that can be applied to surfaces such as brick, gas concrete, pumice, briquette wall on interior and exterior facades, providing adhesion and easy application.

USAGE AREAS:

- It provides the possibility of machine application on the surfaces of masonry materials such as brick, gas concrete and pumice.
- It has high adhesion stability.
- Since it is applied with a machine and it is a ready-made product, time and labor are saved.
- It provides to obtain surfaces that are harder, smoother and more resistant to impacts than old plasters.
- Performs both rough and fine plastering processes by applying a single layer.

 İç ve dış cephelerde tuğla, gaz beton, pomza, briket duvar gibi yüzeylere uygulanabilen yapışma ve rahat uygulama olanağı sağlayan çimento esaslı, modifiye polimer katkılı makinee ve el sıvasıdır.

KULLANIM ALANLARI:

- Özellikle tuğla, gaz beton, pomza gibi duvar örgü malzemelerinin yüzeylerine makine ile uygulama olanağı sağlar.
- Yüksek yapışma stabilitesine sahiptir. • Makine ile uygulandığından ve hazır bir ürün olması zaman ve işçilikten kazanılır.
- Eski sıvalara göre daha sert, düzgün ve darbelere karşı dayanıklı yüzeylerin elde edilmesini sağlar. • Tek kat uygulama yaparak hem kaba hem de ince sıva işlemini görür.



VERPACKUNG / PACKAGING / AMBALAJ

35 Kg.

Kraftbeutel / Kraft Bag / Kraft Torba

TECHNISCHE SPEZIFIKATIONEN / TECHNICAL SPECIFICATIONS / TEKNİK ÖZELLİKLERİ

Farbe / Colour / Renk	Grau weiß / Grey-White / Gri-Beyaz
Mischverhältnis / Mixing ratio / Karışım Oranı	35 kg Produkt werden mit durchschnittlich 8-9 Liter Wasser gemischt / 35 kg product is mixed with an average of 8-9 liters of water / 35 kg.lık ürün ortalama 8-9 lt su ile karıştırılır.
Verbrauch / Consumption / Tüketim	16 -17 kg für 1 m ² / 16 -17 kg for 1 m ² / 1 m ² için 16 -17 kg.
Topfzeit / Pot Life / Kap Ömrü	3-4 Stunde/Hour/Saat
Reifezeit / Maturation Time / Olgunlaşma Süresi	5 Minute / Dakika



KR BAUSTOFFE

"Geheimnis der Meister"

KRK-X60

- Perlit-Maschinenputz auf Zementbasis
- Cement Based Perlite Machine Plaster
- Çimento Esaslı Perlitli Makine Sıvası



Es ist ein Perlit-Maschinenputz auf Zementbasis, der maschinell auf Oberflächen wie Ziegel, Gasbeton, Bimsstein, Brikettwand an Innen- und Außenfassaden aufgetragen werden kann und eine Haftung und eine einfache Anwendung bietet.

EINSATZBEREICHE:

• Es bietet die Möglichkeit des maschinellen Auftrags auf die Oberflächen von Mauerwerksmaterialien wie Ziegel, Porenbeton, Bimsstein. Es hat eine hohe Adhäsionsstabilität. Da es maschinell verarbeitet wird und es sich um ein fertiges Produkt handelt, werden Zeit und Arbeit gespart. Es sorgt für härtere, glattere und widerstandsfähigere Oberflächen als alte Putze. Führt sowohl Grob- als auch Feinputzverfahren durch, indem eine einzige Schicht aufgetragen wird. Es reduziert die Baulast durch Blähperlit und sorgt für Schalldämmung im Gebäude sowie Wärmedämmung. Es zersetzt sich nicht, da es aus natürlichen Stoffen besteht. Dank der Pore im Perlit lässt es Strukturen atmen.



It is a cement-based perlite machine plaster that can be applied by machine to surfaces such as brick, gas concrete, pumice, briquette wall on interior and exterior facades, providing adhesion and easy application.

USAGE AREAS:

• It provides the possibility of machine application on the surfaces of masonry materials such as brick, gas concrete, pumice. It has high adhesion stability. Since it is applied with a machine and it is a ready-made product, time and labor are saved. It provides to obtain surfaces that are harder, smoother and more resistant to impacts than old plasters. Performs both rough and fine plastering processes by applying a single layer. It reduces the building load by means of expanded perlite and provides sound insulation in the building as well as thermal insulation. It does not decompose as it consists of natural substances. Thanks to the pore in perlite, it allows structures to breathe.



İç ve dış cephelerde tuğla, gaz beton, bims, briket duvar gibi yüzeylere makine ile uygulanabilen yapışma ve rahat uygulama olanağı sağlayan çimento esaslı perlitli makine sıvasıdır.

KULLANIM ALANLARI:

• Özellikle tuğla, gaz beton, bims gibi duvar örgü malzemelerinin yüzeylerine makine ile uygulama olanağı sağlar. • Yüksek yapışma stabilitesine sahiptir. • Makine ile uygulandığından ve hazır bir ürün olması zaman ve işçilikten kazanılır. • Eski sıvalara göre daha sert, düzgün ve darbelere karşı dayanıklı yüzeylerin elde edilmesini sağlar. • Tek kat uygulama yaparak hem kaba hem de ince sıva işlemini görür. • Genleştirilmiş perlit vasıtasıyla bina yükünü azaltır ve ısı yalıtımının haricinde binada ses yalıtımı da sağlar. • Doğal maddelerden oluştuğu için bozunma yapmaz. • Perlitteki gözenek sayesinde yapıların nefes almasını sağlar.

TECHNISCHE SPEZIFIKATIONEN / TECHNICAL SPECIFICATIONS / TEKNİK ÖZELLİKLERİ

Farbe / Colour / Renk	Grau weiß / Grey-White / Gri-Beyaz
Mischverhältnis / Mixing ratio / Karışım Oranı	35 kg Produkt werden mit durchschnittlich 8-9 Liter Wasser gemischt / 35 kg product is mixed with an average of 8-9 liters of water / 35 kg.lık ürün ortalama 8-9 lt su ile karıştırılır.
Verbrauch / Consumption / Tüketim	6-8 kg für 1 m ² / 6-8 kg for 1 m ² / 1 m ² için 6-8 kg.
Topfzeit / Pot Life / Kap Ömrü	3-4 Stunde/Hour/Saat
Reifezeit / Maturation Time / Olgunlaşma Süresi	5 Minute / Dakika



VERPACKUNG / PACKAGING / AMBALAJ

35 Kg.

Kraftbeutel / Kraft Bag / Kraft Torba

KRK-X70

- Wärme- und Schallschutzputz
- Heat and Sound Insulation Plaster
- Isı ve Ses Yalıtım Sıvası



Innenfassaden, angrenzende Wände, Wohnungen, Treppen- und Aufzugsschächte, Ziegel, Gasbeton, Bimsstein, Brikettwand etc. Es handelt sich um einen leichten Dämmputz auf Perlit-Zement-Basis, der auf Oberflächen verwendet wird, der eine Wärme- und Schalldämmung bietet.

EINSATZBEREICHE:

- Besonders dort, wo Schallschutz erwünscht ist; an benachbarten Wänden, Wohnungen und Aufzugsschächten; Es dient zur Wärme- und Schalldämmung von Oberflächen von Mauerwerksmaterialien wie Ziegel, Gasbeton, Bims.
- Dank des enthaltenen Blähperlits bietet es neben der Schalldämmung auch eine Wärmedämmung in Gebäuden.
- Es zersetzt sich nicht, da es aus natürlichen Stoffen besteht.
- Es lässt Gebäude atmen.



Interior facades, adjacent walls, apartments, stairs and elevator shafts, brick, gas concrete, pumice, briquette wall etc. It is a perlite cement based light insulation plaster used on surfaces that provides heat and sound insulation.

USAGE AREAS:

- Especially where sound insulation is desired; on neighboring walls, apartments and elevator shafts; It is used to provide heat and sound insulation on the surfaces of masonry materials such as brick, gas concrete, pumice.
- Thanks to the expanded perlite it contains, it also provides thermal insulation in buildings besides sound insulation.
- It does not decompose as it consists of natural substances.
- It allows buildings to breathe.



İç cepheler, komşu duvarlarda, apartman, merdiven ve asansör boşluklarında, tuğla, gaz beton, bims, briket duvar vb. yüzeylerde kullanılan ısı ve ses yalıtımı sağlayan perlitli çimento esaslı hafif yalıtım sıvasıdır.

KULLANIM ALANLARI:

- Özellikle ses yalıtımı istenen; komşu duvarlarda, apartman ve asansör boşluklarında; tuğla, gaz beton, bims gibi duvar örgü malzemelerinin yüzeylerinde ısı ve ses yalıtımı sağlamak amaçlı kullanılır.
- Bünyesindeki genleştirilmiş perlit sayesinde ses yalıtımı haricinde yapılarda ısı yalıtımı da sağlar.
- Doğal maddelerden oluştuğu için bozunma yapmaz.
- Binaların nefes almasını sağlar.



VERPACKUNG / PACKAGING / AMBALAJ

9 Kg.

Kraftbeutel / Kraft Bag / Kraft Torba

TECHNISCHE SPEZIFIKATIONEN / TECHNICAL SPECIFICATIONS / TEKNİK ÖZELLİKLERİ

Farbe / Colour / Renk	Grau weiß / Grey-White / Gri-Beyaz
Mischverhältnis / Mixing ratio / Karışım Oranı	9 kg Produkt werden mit durchschnittlich 9-10 Liter Wasser gemischt / 9 kg product is mixed with an average of 9-10 liters of water / 9 kg.lık ürün ortalama 9-10 lt su ile karıştırılır.
Verbrauch / Consumption / Tüketim	3-4 kg für/for/için 1 m ² (In einer einzigen Schicht 1 cm Auftrag/In a single layer 1 cm application/Tek kat 1 cm uygulamada)
Topfzeit / Pot Life / Kap Ömrü	2 Stunde/Hour/Saat
Reifezeit/Maturation Time/Olgunlaşma Süresi	5 Minute / Dakika



Dekorative
Klebstoffgruppe

Decorative
Adhesive Group

Dekoratif
Yapıştırıcı Grubu

KRK BAUSTOFFE

"Geheimnis der Meister"

KRK-7000

- Innen- und Außenspachtel
- Interior and Exterior Putty
- İç ve Dış Cephe Macunu

 Es ist ein zementbasierter Fassadenkitt, der für ein perfektes Erscheinungsbild an Innen- und Außenfassaden sorgt, langlebig, sehr widerstandsfähig gegen Einflüsse wie Regen und Sonne ist, den Farbverbrauch reduziert und die Lebensdauer der Farbe verlängert.

EINSATZBEREICHE:

- Es wird in Oberflächenanwendungen wie Gasbeton, Bims, Dickputz, Dünnputz, Sichtbeton verwendet.

 It is a cement-based facade coating putty that provides a perfect appearance on interior and exterior facades, is long-lasting, very resistant to factors such as rain and sun, reduces paint consumption and extends the life of the paint.

USAGE AREAS:

- It is used in surface applications such as gas concrete, pumice, thick plaster, thin plaster, exposed concrete.

 İç ve dış cephelerde mükemmel görünüm sağlayan, uzun ömürlü, yağmur, güneş gibi etkenlere karşı çok dayanıklı, boya sarfiyatını azaltan ve boyanın ömrünü uzatan çimento esaslı cephe kaplama macunudur.

KULLANIM ALANLARI:

- Gazbeton, bims, kalın sıva, ince sıva, brüt beton gibi yüzey uygulamalarında kullanılır.



VERPACKUNG / PACKAGING / AMBALAJ

25 Kg.

Kraftbeutel / Kraft Bag / Kraft Torba

TECHNISCHE SPEZIFIKATIONEN / TECHNICAL SPECIFICATIONS / TEKNİK ÖZELLİKLERİ

Farbe / Colour / Renk	Grau weiß / Grey-White / Gri-Beyaz
Mischverhältnis / Mixing ratio / Karışım Oranı	25 kg Produkt werden mit durchschnittlich 5-6 Liter Wasser gemischt / 25 kg product is mixed with an average of 5-6 liters of water / 25 kg.lık ürün ortalama 5-6 lt su ile karıştırılır.
Verbrauch / Consumption / Tüketim	1 m ² dicke Paste für den Durchschnitt / thick paste for average / için kalın macun ortalama 4 - 6 kg., feine Paste durchschnittlich / fine paste average / ince macun ortalama 2 - 3 kg.
Topfzeit / Pot Life / Kap Ömrü	2 Stunde/Hour/Saat

KRK-6100

- Dicker Rissreparaturmörtel
- Thick Crack Repair Mortar
- Kalın Çatlak Tamir Harcı

 Es handelt sich um einen nichttragenden Reparaturmörtel auf Zementbasis mit modifiziertem Polymerzusatz, der für dicke Risse zwischen 5 mm und 15 mm verwendet wird.

EINSATZBEREICHE:

- Es hat eine hohe Haftfestigkeit bei der Reparatur von dicken Rissen zwischen 5 mm und 15 mm im Innen- und Außenbereich.
- Es ist einfach zu bedienen.

 It is a cement based, modified polymer added non-structural repair mortar used for thick cracks between 5 mm and 15 mm.

USAGE AREAS:

- It has high adhesion stability in the repair of thick cracks between 5 mm and 15 mm indoors and outdoors.
- It is easy to use.

 5 mm – 15 mm arası kalın çatlaklar için kullanılan, çimento esaslı, modifiye polimer katkılı yapısal olmayan tamir harcıdır.

KULLANIM ALANLARI:

- İç ve dış mekânlarda 5 mm – 15 mm arası kalın çatlakların tamiratında yüksek yapışma stabilitesine sahiptir.
- Kullanımı kolaydır.



VERPACKUNG / PACKAGING / AMBALAJ

25 Kg.

Kraftbeutel / Kraft Bag / Kraft Torba

TECHNISCHE SPEZIFIKATIONEN / TECHNICAL SPECIFICATIONS / TEKNİK ÖZELLİKLERİ

Farbe / Colour / Renk	Grau weiß / Grey-White / Gri-Beyaz
Mischverhältnis / Mixing ratio / Karışım Oranı	25 kg Produkt werden mit durchschnittlich 6,5-7,5 Liter Wasser gemischt / 25 kg product is mixed with an average of 6,5-7,5 liters of water / 25 kg.lık ürün ortalama 6,5-7,5 lt su ile karıştırılır.
Verbrauch / Consumption / Tüketim	4 - 4,5 kg pro/per/için 1 m ² . (3 mm Auftragsstärke/application thickness/uygulama kalınlığında)
Topfzeit / Pot Life / Kap Ömrü	2 Stunde/Hour/Saat



KRK BAUSTOFFE

"Geheimnis der Meister"

KRK-6110

- Strukturreparaturmörtel
- Structural Repair Mortar
- Yapısal Tamir Harcı

 Zementbasierter, modifizierter polymerverstärkter und faserverstärkter, hochfester, einkomponentiger Strukturreparaturmörtel, der im Innen- und Außenbereich dünn oder dick aufgetragen werden kann.

EINSATZBEREICHE:

- Es wird verwendet zur Armierung von bewehrten und unbewehrten Oberflächen von Stahlbeton und Fertigteilen, Reparatur von Innen- und Außenfassaden, Reparatur und Ausgleich von Oberflächenfehlern von hochfesten Betonelementen, Reparatur von Oberflächen mit leichter und mittlerer Verkehrsbelastung, Füllen von Stangenlöchern.

 Cement-based, modified polymer added and fiber reinforced, high-strength, single-component structural repair mortar that can be applied thinly or thickly indoors and outdoors.

USAGE AREAS:

- It is used for reinforcing reinforced and non-reinforced surfaces of reinforced concrete and prefabricated structures, repairing interior and exterior facades, repairing and leveling surface defects of high-strength concrete elements, repairing surfaces with light and moderate traffic loads, filling rod holes.

 Çimento esaslı, modifiye polimer katkılı ve elyaf takviyeli iç ve dış mekanlarda ince ve kalın uygulanabilen yüksek mukavemetli tek bileşenli yapı tamir harcıdır.

KULLANIM ALANLARI:

- Betonarme ve prafabrik yapıların donatılı ve donatısız yüzeylerinin güçlendirilmesinde, iç ve dış cephelerinin onarımında, yüksek dayanımlı beton elemanlarının yüzey bozuklarının tamiri ve tesviyesinde, hafif ve orta şiddette trafik yükü olan yüzeylerin tamirinde, tij deliklerinin doldurulmasında kullanılır.



VERPACKUNG / PACKAGING / AMBALAJ

25 Kg.

Kraftbeutel / Kraft Bag / Kraft Torba

TECHNISCHE SPEZIFIKATIONEN / TECHNICAL SPECIFICATIONS / TEKNİK ÖZELLİKLERİ

Farbe / Colour / Renk	Grau / Grey / Gri
Mischverhältnis / Mixing ratio / Karışım Oranı	25 kg Produkt werden mit durchschnittlich 4,5-5 Liter Wasser gemischt / 25 kg product is mixed with an average of 4,5-5 liters of water / 25 kg.lık ürün ortalama 4,5-5 lt su ile karıştırılır.
Verbrauch / Consumption / Tüketim	4 - 4,5 kg pro/per/için 1 m ² .
Topfzeit / Pot Life / Kap Ömrü	2 Stunde/Hour/Saat

KRK-6120

- Dünner Rissreparaturmörtel
- Thin Crack Repair Mortar
- İnce Çatlak Tamir Harcı

 Zementbasierter, nichttragender Oberflächenreparaturmörtel mit modifiziertem Polymerzusatz zur Reparatur von dünnen Rissen zwischen 2 mm und 5 mm.

EINSATZBEREICHE:

- Es wird zur Rissreparatur von dünnen Rissen zwischen 2 mm und 5 mm im Innen- und Außenbereich verwendet.
- Es hat eine hohe Adhäsionsstabilität.
- Es ist einfach zu bedienen.

 Cement-based, modified polymer added, non-structural surface repair mortar used for the repair of thin cracks between 2 mm and 5 mm.

USAGE AREAS:

- It is used for repairing the cracks of thin cracks between 2 mm and 5 mm indoors and outdoors.
- It has high adhesion stability.
- It is easy to use.

 Çimento esaslı, modifiye polimer katkı, 2 mm – 5 mm arası ince çatlakların tamiri için kullanılan, yapısal olmayan yüzey tamir harcıdır.

KULLANIM ALANLARI:

- İç ve dış mekânlarda 2 mm – 5 mm arası ince çatlakların çatlaklarının tamiratında kullanılır.
- Yüksek yapışma stabilitesine sahiptir.
- Kullanımı kolaydır.



VERPACKUNG / PACKAGING / AMBALAJ

25 Kg.

Kraftbeutel / Kraft Bag / Kraft Torba

TECHNISCHE SPEZIFIKATIONEN / TECHNICAL SPECIFICATIONS / TEKNİK ÖZELLİKLERİ

Farbe / Colour / Renk	Grau weiß / Grey-White / Gri-Beyaz
Mischverhältnis / Mixing ratio / Karışım Oranı	25 kg Produkt werden mit durchschnittlich 6,5-7,5 Liter Wasser gemischt / 25 kg product is mixed with an average of 6,5-7,5 liters of water / 25 kg.lık ürün ortalama 6,5-7,5 lt su ile karıştırılır.
Verbrauch / Consumption / Tüketim	4 - 4,5 kg pro/per/için 1 m ² . (3 mm Auftragsstärke/application thickness/uygulama kalınlığında)
Topfzeit / Pot Life / Kap Ömrü	2 Stunde/Hour/Saat

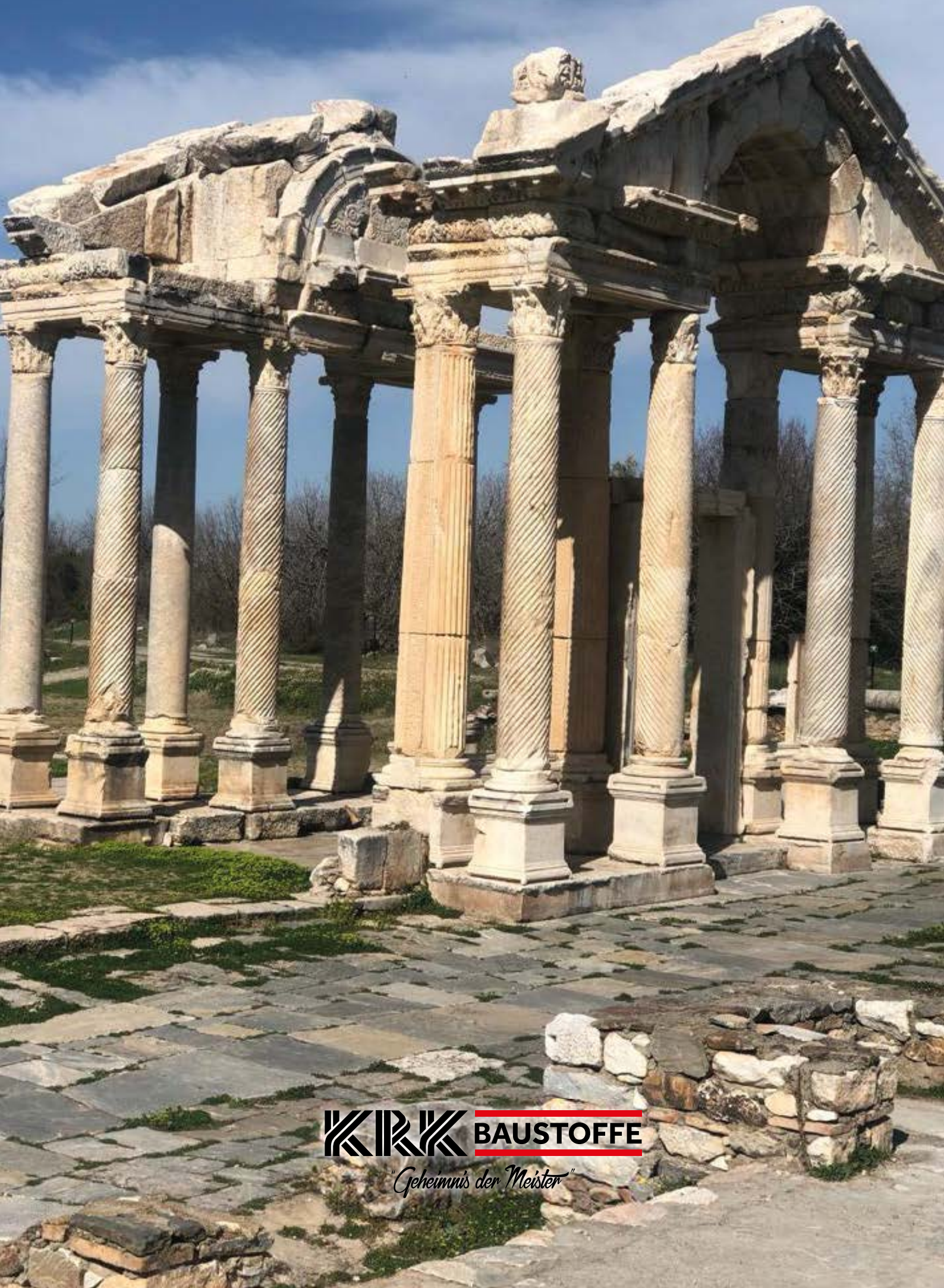

KRK BAUSTOFFE

"Geheimnis der Meister"

KRK-6130

• Khorasan Mörser
• Khorasan Mortar
• Khorasan Harcı

 Es ist ein speziell entwickelter Mörtel für die Restaurierung historischer Gebäude. Es ist ein Mörtel mit Atmungsaktivität und hoher Wasserdampfdurchlässigkeit.

EINSATZBEREICHE:

• Verputzen und Reparieren von historischen Mauerwerksstrukturen und Verbinden historischer Artefakte untereinander und Füllen und Reparieren der Fugenzwischenräume zwischen diesen Steinen; Es wird bei Verputz- und Reparaturarbeiten von gemauerten Kuppeln und Gewölben verwendet.

 It is a specially designed mortar for the restoration of historical buildings. It is a mortar with breathing feature and high water vapor permeability.

USAGE AREAS:

• Plastering and repairing historical masonry structures and connecting historical artifacts to each other and filling and repairing the joint gaps between these stones; It is used in plastering and repair works of masonry domes and vaults.

 Tarihi yapıların restorasyonu için özel olarak tasarlanmış bir harçtır. Nefes alma özelliği olan, su buharı geçirgenliği yüksek bir harçtır.

KULLANIM ALANLARI:

• Tarihi kagir yapıların sıvanması, tamiri ve tarihi eser taşların birbirine bağlanmasında ve bu taşlar arasındaki derz boşlukların doldurulması ve onarılmasında; kâgir kubbu ve tonozların sıva ve tamir işlerinde kullanılır.



VERPACKUNG / PACKAGING / AMBALAJ

25 Kg.

Kraftbeutel / Kraft Bag / Kraft Torba

TECHNISCHE SPEZIFIKATIONEN / TECHNICAL SPECIFICATIONS / TEKNİK ÖZELLİKLERİ

Farbe / Colour / Renk	Off White und Pink / Off White und Pink / Kırık Beyaz ve Pembe
Mischverhältnis / Mixing ratio / Karışım Oranı	25 kg Produkt werden mit durchschnittlich 6,5 - 7,5 Liter Wasser gemischt / 25 kg product is mixed with an average of 6,5 - 7,5 liters of water / 25 kg.lık ürün ortalama 6,5 - 7,5 lt su ile karıştırılır.
Verbrauch / Consumption / Tüketim	4 - 4,5 kg pro/per/için 1 m ² . (3 mm Auftragsstärke/application thickness/uygulama kalınlığında)
Topfzeit / Pot Life / Kap Ömrü	2 Stunde/Hour/Saat

KRK-SELF-L

- Selbstnivellierung
- Self Levelling
- Kendiliğinden Yayılan Tesviye Şapı

 Es ist ein mit Spezialchemikalien verstärkter Fertigmörtel auf Zementbasis zum Selbstverlaufen und Verlaufen.

EINSATZBEREICHE:

- Aragonit Fließestrich ist ein Ausgleichsmörtel.
- Erzeugt nach dem Aushärten eine glatte und harte Oberfläche.
- Aus diesem Grund wird es zum Glätten von Oberflächen vor Anwendungen wie Keramik aller Art, Laminatböden, Holzparkett, PVC-Beschichtung verwendet.

 It is a cement-based, ready-made mortar reinforced with special chemicals for self-levelling and leveling.

USAGE AREAS:

- Aragonit Self Leveling Screed is a leveling mortar.
- It creates a smooth and hard surface after setting.
- For this reason, it is used for surface smoothing before applications such as all kinds of ceramics, laminate flooring, wooden parquet, PVC coating.

 Çimento esaslı, kendiliğinden yayılması ve tesviye alması için özel kimyasallar takviye edilmiş hazır bir harçtır.

KULLANIM ALANLARI:

- Aragonit Kendiliğinden Yayılan Tesviye Şapı bir düzeltme harcıdır.
- Priz yaptıktan sonra pürüzsüz ve sert bir yüzey oluşturur.
- Bu sebeple her türlü seramik, laminat parke, ahşap parke, PVC kaplama gibi uygulamalardan önce yüzey düzeltme amacıyla kullanılır.



VERPACKUNG / PACKAGING / AMBALAJ

25 Kg.

Kraftbeutel / Kraft Bag / Kraft Torba

TECHNISCHE SPEZIFIKATIONEN / TECHNICAL SPECIFICATIONS / TEKNİK ÖZELLİKLERİ

Farbe / Colour / Renk	Grau / Grey / Gri
Mischverhältnis / Mixing ratio / Karışım Oranı	25 kg Produkt werden mit durchschnittlich 8-10 Liter Wasser gemischt / 25 kg product is mixed with an average of 8-10 liters of water / 25 kg.lık ürün ortalama 8-10 lt su ile karıştırılır.
Verbrauch / Consumption / Tüketim	4,5 - 5 kg pro/per/için 1 m ² .
Topfzeit / Pot Life / Kap Ömrü	20-25 Minute/Dakika (Je nach Umgebungsbedingungen / According to ambient conditions / Ortam şartlarına göre)



KRK BAUSTOFFE

"Geheimnis der Meister"

KRK-6140

- Super-Selbstnivellierung
- Super Self Levelling
- Kendiliğinden yayılan Süper Şap

 Es ist ein mit Spezialchemikalien verstärkter Fertigmörtel auf Zementbasis zum Selbstverlaufen und Verlaufen. Es wird wegen seiner sehr hohen Selbstnivellierungsfunktion als Super Screed bezeichnet.

EINSATZBEREICHE:

- Aragonit Selbstnivellierender Supernivellierungsstrich ist ein Ausgleichsmörtel.
- Erzeugt nach dem Aushärten eine glatte und harte Oberfläche.
- Aus diesem Grund wird es zum Glätten von Oberflächen vor Anwendungen wie Keramik aller Art, Laminatböden, Holzparkett, PVC-Beschichtung verwendet.

 It is a cement-based, ready-made mortar reinforced with special chemicals for self-levelling and leveling. It is named as Super Screed because of its very high self-levelling feature.

USAGE AREAS:

- Aragonit Self Leveling Super Leveling Screed is a leveling mortar.
- It creates a smooth and hard surface after setting.
- For this reason, it is used for surface smoothing before applications such as all kinds of ceramics, laminate flooring, wooden parquet, PVC coating.

 Çimento esaslı, kendiliğinden yayılması ve tesviye alması için özel kimyasallar takviye edilmiş hazır bir harçtır. Kendiliğinden yayılma özelliği çok yüksek olduğu için Süper Şap olarak adlandırılmıştır.

KULLANIM ALANLARI:

- Aragonit Kendiliğinden Yayılan Süper Tesviye Şapı bir düzeltme harcıdır.
- Priz yaptıktan sonra pürüzsüz ve sert bir yüzey oluşturur.
- Bu sebeple her türlü seramik, laminat parke, ahşap parke, PVC kaplama gibi uygulamalardan önce yüzey düzeltme amacıyla kullanılır.



VERPACKUNG / PACKAGING / AMBALAJ
25 Kg.

Kraftbeutel / Kraft Bag / Kraft Torba

TECHNISCHE SPEZIFIKATIONEN / TECHNICAL SPECIFICATIONS / TEKNİK ÖZELLİKLERİ

Farbe / Colour / Renk	Grau / Grey / Gri
Mischverhältnis / Mixing ratio / Karışım Oranı	25 kg Produkt werden mit durchschnittlich 8-10 Liter Wasser gemischt / 25 kg product is mixed with an average of 8-10 liters of water / 25 kg.lık ürün ortalama 8-10 lt su ile karıştırılır.
Verbrauch / Consumption / Tüketim	4,5 - 5 kg pro/per/için 1 m ² .
Topfzeit / Pot Life / Kap Ömrü	20-25 Minute/Dakika (Je nach Umgebungsbedingungen / According to ambient conditions / Ortam şartlarına göre)

KRK-6160

- Einfach zu verarbeitender Fertiger Grobestrich
- Easy-to-ApPLY Ready Rough Screed
- Kolay Uygulanan Hazır Kaba Şap

 Es handelt sich um einen Fertigmörtel auf Zementbasis mit chemischen Zusätzen, der eine porenfreie Struktur im Estrich erzeugt und sich leicht verteilen lässt.

EINSATZBEREICHE:

• T 100 ist ein Korrekturmörtel. Es erzeugt nach dem Abbinden eine glatte und harte Oberfläche. Aus diesem Grund wird es zum Glätten von Oberflächen vor Anwendungen wie Keramik aller Art, Laminatböden, Holzparkett, PVC-Beschichtung verwendet.

 It is a cement-based, ready-made mortar containing chemical additives that creates a non-porous structure in the screed and allows easy spreading.

USAGE AREAS:

• T 100 is a correction mortar. It creates a smooth and hard surface after setting. For this reason, it is used for surface smoothing before applications such as all kinds of ceramics, laminate flooring, wooden parquet, PVC coating.

 Çimento esaslı, şapta gözeneksiz yapı oluşturan ve kolay yayılma sağlayan kimyasal katkıları içeren hazır bir harçtır.

KULLANIM ALANLARI:

• T 100 bir düzeltme harcıdır. Priz yaptıktan sonra pürüzsüz ve sert bir yüzey oluşturur. Bu sebeple her türlü seramik, laminat parke, ahşap parke, PVC kaplama gibi uygulamalardan önce yüzey düzeltme amacıyla kullanılır.



VERPACKUNG / PACKAGING / AMBALAJ

25 Kg.

Kraftbeutel / Kraft Bag / Kraft Torba

TECHNISCHE SPEZIFIKATIONEN / TECHNICAL SPECIFICATIONS / TEKNİK ÖZELLİKLERİ

Farbe / Colour / Renk	Grau / Grey / Gri
Mischverhältnis / Mixing ratio / Karışım Oranı	25 kg Produkt werden mit durchschnittlich 4-5 Liter Wasser gemischt / 25 kg product is mixed with an average of 4-5 liters of water / 25 kg.lık ürün ortalama 4-5 lt su ile karıştırılır.
Verbrauch / Consumption / Tüketim	14 - 15 kg pro/perfiçin 1 m ² . (1 cm dick / thick / kalınlıkta)
Topfzeit / Pot Life / Kap Ömrü	20-25 Minute/Dakika

KRK-6150

- Isoliermörtel aus kristallisiertem Wasser
- Crystallized Water Insulation Morta
- Kristalize Su İzolasyon Harcı

 Es handelt sich um eine zementgebundene, einkomponentige Abdichtung, die im Innen- und Außenbereich zum Schutz von Bauteilen vor Wasser und Feuchtigkeit eingesetzt wird, die Kapillarräume im Gebäude ausfüllt, beständig gegen negativen und positiven Wasserdruck ist.

EINSATZBEREICHE:

• Im Innen- und Außenbereich, Schutz von Fundamenten, Vorhang- und Stützwänden und Kellern von Gebäuden vor Wasser und Feuchtigkeit, Isolierung von Bauwerken wie Schwimmbecken, Wassertanks und Abwasseraufbereitungsanlagen sowie Schutz von nassen Böden wie Badezimmer, Toiletten und Bauwerken wie B. Terrassen und Balkone vor Wasser und Feuchtigkeit geschützt und isoliert verwendet werden.

 It is a cement-based, single-component waterproofing material that is used indoors and outdoors to protect building elements from water and humidity, fills the capillary spaces in the building, is resistant to negative and positive water pressure.

USAGE AREAS:

• In indoor and outdoor, protecting foundation, curtain and retaining walls and basements of buildings from water and moisture, isolation of structures such as pools, water tanks and waste water treatment plants, and protection of wet floors such as bathrooms, toilets and structures such as terraces and balconies from water and moisture. and used in isolation.

 İç ve dış mekânlarda, yapı elemanlarının sudan ve nemden korunmasında kullanılan, yapıdaki kapiler boşlukları dolduran, negatif ve pozitif su basıncına dayanıklı, çimento esaslı, tek bileşenli su izolasyon malzemesidir.

KULLANIM ALANLARI:

• İç ve dış mekânlarda, temel, perde ve istinat duvarları ile binaların bodrum katlarının su ve nemden korunmasında, havuz, su deposu ve atık su arıtma tesisi gibi yapıların izolasyonunda, banyo, tuvalet gibi ıslak zeminler ile teras, balkon gibi yapıların sudan ve nemden korunmasında ve izolasyonunda kullanılır.



VERPACKUNG / PACKAGING / AMBALAJ

20 Kg.

Kraftbeutel / Kraft Bag / Kraft Torba

TECHNISCHE SPEZIFIKATIONEN / TECHNICAL SPECIFICATIONS / TEKNİK ÖZELLİKLERİ

Farbe / Colour / Renk	Grau / Grey / Gri
Mischverhältnis / Mixing ratio / Karışım Oranı	Etwa 30 % des Pulverprodukts werden mit Wasser vermischt. / Approximately 30% of the powder product is mixed with water. / Toz ürünün yaklaşık %30'u kadar su ile karıştırılır.
Verbrauch / Consumption / Tüketim	1,5-2 kg pro/per/için 1 m ² .
Topfzeit / Pot Life / Kap Ömrü	30 Minute/Dakika



**Abdichtungs-
produkte**

**Waterproofing
Products**

**Su Yalıtım
Ürünleri**

KRK BAUSTOFFE

"Geheimnis der Meister"

KRK-K5

- Halbflexibles Zweikomponenten-Dichtungsmaterial
- Two Component Semi-Flexible Waterproofing Material
- İki Bileşenli Yarı Esnek Su Yalıtım Malzemesi

 Es ist ein Zweikomponenten-Abdichtungsmaterial auf Zement- und Acrylbasis, das auf Beton- und Zementputzen gegen Leckagen und Oberflächenwasser aufgetragen wird.

EINSATZBEREICHE:

- In allen Strukturen,
- Besonders an feuchten Orten wie Balkonen, Bädern, Toiletten und Küchen,
- Es wird als Abdichtungsmaterial in unter keramischen Beschichtungen verwendet.

 It is a cement and acrylic based, two component waterproofing material applied on concrete and cement based plasters against leakage and surface water.

USAGE AREAS:

- In all structures,
- Especially in wet places such as balconies, bathrooms, toilets and kitchens,
- It is used as a waterproofing material in under ceramic coatings.

 Çimento ve akrilik esaslı, sızıntı ve yüzey sularına karşı beton ve çimento esaslı sıvalar üzerine uygulanan, iki bileşenli su yalıtım malzemesidir.

KULLANIM ALANLARI:

- Tüm yapılarda,
- Özellikle balkon, banyo, tuvalet ve mutfak gibi ıslak mekanlarda,
- Seramik altı kaplamalarda su yalıtım malzemesi olarak kullanılır.



VERPACKUNG / PACKAGING / AMBALAJ

20 Kg.

Kraftbeutel / Kraft Bag / Kraft Torba

5 Kg.

Plastikflasche / Plastic bottle / Plastik Bidon

TECHNISCHE SPEZIFIKATIONEN / TECHNICAL SPECIFICATIONS / TEKNİK ÖZELLİKLERİ

Farbe / Colour / Renk	Staub/Dust/Toz: Grau/Grey/Gri flüssig/liquid/Sıvı: weiß/White/Beyaz
Haftkraft / Adhesion Strength / Yapışma Dayanımı	≥ 1,5 N/mm ²
Druckwasserbeständigkeit / Pressure water resistance / Basıncılı su dayanımı	2 bar pozitif
Kapillare Wasseraufnahme / Capillary water absorption / Kapiler su emmesi (TS EN 12808-5)	≤ 0,10 gr (4 Stunden später/ hours later/saat sonra)
Temperatur des aufzubringenden Bodens / Temperature of the floor to be applied / Uygulanacak zeminin sıcaklığı	+5 °C +25 °C
Betriebstemperatur / Service Temperature / Servis Sıcaklığı	-20 °C +80 °C
Reifezeit / Maturation time / Olgunlaştırma süresi	3-5 Minute/dakika
Mörtel nutzbare Zeit / Mortar usable time / Harcin kullanılabilme süresi	Max. 2 Stunde/Hours/Saat
Zeit zwischen den Mänteln zu warten / Time to wait between coats / Katlar arasında beklenilmesi gereken süre	Min. 6 Stunde/Hours/Saat
Zeit für die Keramikanwendung zu warten / Time to wait for ceramic application / Üzerine seramik uygulanması için beklenilmesi gereken süre	Min. 3 Tag/Day/Gün

KRK-K10

- Vollflexibles Zweikomponenten-Dichtungsmaterial
- Two Component Fully Flexible Waterproofing Material
- İki Bileşenli Tam Esnek Su Yalıtım Malzemesi

 Zement- und acrylbasiertes, vollelastisches Zweikomponenten-Abdichtungsmaterial, das auf Beton-, Vorhang- und Zementputzen aus der Richtung des Wassers aufgetragen wird, gegen Leckagen und Oberflächenwasser.

EINSATZBEREICHE:

- In allen Strukturen,
- An Fundament- und Stützmauern,
- An feuchten Orten wie Balkonen, Bädern, Toiletten und Küchen,
- Auf Terrassen (sofern die Oberseite geschützt ist),
- Es wird als unterkeramisches Abdichtungsmaterial in Schwimmbädern und Wassertanks verwendet.

 It is a two-component, fully elastic waterproofing material that is cement and acrylic based, applied on concrete, curtain and cement based plasters from the direction the water comes from, against leakage and surface water.

USAGE AREAS:

- In all structures,
- On foundation and retaining walls,
- In wet places such as balconies, bathrooms, toilets and kitchens,
- On terraces (provided that the top is protected),
- It is used as under-ceramic waterproofing material in swimming pools and water tanks.

 Çimento ve akrilik esaslı, sızıntı ve yüzey sularına karşı beton, perde ve çimento esaslı sıvalar üzerine suyun geldiği yönden uygulanan, iki bileşenli tam elastik su yalıtım malzemesidir.

KULLANIM ALANLARI:

- Tüm yapılarda,
- Temel ve istinat duvarlarında,
- Balkon, banyo, tuvalet ve mutfak gibi ıslak mekanlarda,
- Teraslarda (üzeri korunmak şartıyla),
- Yüzme havuzlarında ve su depolarında seramik altı su yalıtım malzemesi olarak kullanılır.



VERPACKUNG / PACKAGING / AMBALAJ

20 Kg.

Kraftbeutel / Kraft Bag / Kraft Torba

10 Kg.

Plastikflasche / Plastic bottle / Plastik Bidon

TECHNISCHE SPEZIFIKATIONEN / TECHNICAL SPECIFICATIONS / TEKNİK ÖZELLİKLERİ

Farbe / Colour / Renk	Staub/Dust/Toz: Grau/Grey/Gri flüssig/liquid/Sıvı: weiß/White/Beyaz
Haftkraft / Adhesion Strength / Yapışma Dayanımı	≥ 1 N/mm ²
Druckwasserbeständigkeit / Pressure water resistance / Basıncılı su dayanımı	7 bar pozitif
Kapillare Wasseraufnahme / Capillary water absorption / Kapiler su emmesi (TS EN 12808-5)	≤ 0,10 gr (4 Stunden später/ hours later/saat sonra)
Temperatur des aufzubringenden Bodens / Temperature of the floor to be applied / Uygulanacak zeminin sıcaklığı	+5 °C +25 °C
Betriebstemperatur / Service Temperature / Servis Sıcaklığı	-20 °C +80 °C
Reifezeit / Maturation time / Olgunlaştırma süresi	3-5 Minute/dakika
Mörtel nutzbare Zeit / Mortar usable time / Harcin kullanılabilme süresi	2 Stunde/Hours/Saat
Zeit zwischen den Mänteln zu warten / Time to wait between coats / Katlar arasında beklenilmesi gereken süre	Min. 5 Stunde/Hours/Saat
Zeit für die Keramikanwendung zu warten / Time to wait for ceramic application / Üzerine seramik uygulanması için beklenilmesi gereken süre	Min. 3 Tag/Day/Gün



KR BAUSTOFFE

"Geheimnis der Meister"

KRK-K15

- UV-beständiges superelastisches Imprägniermaterial
- UV Resistant Super Elastic Waterproofing Material
- UV Dayanımlı Süper Elastik Su Yalıtım Malzemesi



Zement- und acrylbasiertes, UV-beständiges, superelastisches Zweikomponenten-Dichtungsmaterial, das auf Beton- und Zementputzen aus der Richtung des Wasserflusses aufgetragen wird, gegen Leckagen und Oberflächenwasser.

EINSATZBEREICHE:

- In allen Strukturen,
- An feuchten Orten wie Balkonen, Bädern, Toiletten und Küchen,
- Auf Terrassen, Wassertanks, großen Terrassen und beweglichen Böden
- In Elevatorbechern
- Auf Details und Äußerlichkeiten, die nicht abgedeckt werden



Cement and acrylic based, UV resistant, two component super elastic waterproofing material applied on concrete and cement based plasters from the direction of water flow, against leakage and surface water.

USAGE AREAS:

- In all structures,
- In wet places such as balconies, bathrooms, toilets and kitchens,
- On terraces, water tanks, large terraces and movable floors
- In elevator buckets
- On details and exteriors that will not be covered



Çimento ve akrilik esaslı, UV dayanımlı, sızıntı ve yüzey sularına karşı beton, ve çimento esaslı sıvalar üzerine suyun geldiği yönden uygulanan, iki bileşenli süper elastik su yalıtım malzemesidir.

KULLANIM ALANLARI:

- Tüm yapılarda,
- Balkon, banyo, tuvalet ve mutfak gibi ıslak mekanlarda,
- Teraslarda, su depolarında, geniş alanlı teraslarda ve hareketli döşemelerde
- Asansör kovalarında
- Üzeri kaplanmayacak detaylarda ve dış cephelerde



VERPACKUNG / PACKAGING / AMBALAJ

25 Kg.

Kraftbeutel / Kraft Bag / Kraft Torba

8 Kg.

Plastikflasche / Plastic bottle / Plastik Bidon

TECHNISCHE SPEZIFIKATIONEN / TECHNICAL SPECIFICATIONS / TEKNİK ÖZELLİKLERİ

Farbe / Colour / Renk	Staub/Dust/Toz: Grau/Grey/Gri flüssig/liquid/Sıvı: weiß/White/Beyaz
Haftkraft / Adhesion Strength / Yapışma Dayanımı	≥ 1 N/mm ²
Druckwasserbeständigkeit / Pressure water resistance / Basıncılı su dayanımı	7 bar pozitif
Kapillare Wasseraufnahme / Capillary water absorption / Kapiler su emmesi (TS EN 12808-5)	≤ 0,10 gr (4 Stunden später/ hours later/saat sonra)
Temperatur des aufzubringenden Bodens / Temperature of the floor to be applied / Uygulanacak zeminin sıcaklığı	+5 °C +25 °C
Betriebstemperatur / Service Temperature / Servis Sıcaklığı	-20 °C +80 °C
Reifezeit / Maturation time / Olgunlaştırma süresi	3-5 Minute/dakika
Mörtel nutzbare Zeit / Mortar usable time / Harcin kullanılabilme süresi	2 Stunde/Hours/Saat
Zeit zwischen den Mänteln zu warten / Time to wait between coats / Katlar arasında beklenilmesi gereken süre	Min. 5 Stunde/Hours/Saat
Zeit für die Keramikanwendung zu warten / Time to wait for ceramic application / Üzerine seramik uygulanması için beklenilmesi gereken süre	Min. 3 Tag/Day/Gün

KRK-K20

- Einkomponentiges kristallisiertes Imprägniermaterial
- Single Component Crystallized Waterproofing Material
- Tek Bileşenli Kristalize Su Yalıtım Malzemesi

 Zementbasiertes, kristallisiertes Abdichtungsmaterial mit Penetrationseffekt

EINSATZBEREICHE:

- Bei internen und externen Anwendungen auf Untergeschosshöhen,
- Dichtheit von Deckenbetonen und monolithische Bewehrung von Estrichbetonen,
- Beim Schutz von Bodenbetonen gegen Feuchtigkeit und Wasserlecks aus positiven und negativen Richtungen,
- In Aufzugsgruben
- Beim Schutz von Betonbauteilen gegen die Einwirkung korrosiver und gesundheitsschädlicher Salze aus dem Grundwasser,
- Dämmung von Fundamenten, Nassbereichen, Tunneln, Tiefgaragen und Terrassengärten,
- Es wird unter Fliesen in Nassbereichen wie Küchen, Balkonen und Toiletten verwendet.

 Cement Based, Crystallized Waterproofing Material with Penetration Effect

USAGE AREAS:

- In internal and external applications at subbasement elevations,
- Impermeability of floor concretes and monolithic reinforcement of screed concretes,
- In the protection of floor concretes against moisture and water leaks from positive and negative directions,
- In elevator pits
- In the protection of concrete elements against the effects of corrosive and harmful salts carried by groundwater,
- Insulation of foundations, wet areas, tunnels, underground garages and terrace gardens,
- It is used in under tile applications in wet areas such as kitchens, balconies and toilets.

 Çimento Esaslı Penetrasyon Etkili, Kristalize Su Yalıtım Malzemesi

KULLANIM ALANLARI:

- Su basmanı kotlarında içten ve dıştan uygulamalarda, • Asansör çukurlarında
- Döşeme betonlarının geçirimsizliği ve şap betonlarının monolitik güçlendirmesinde,
- Zemin betonlarının pozitif ve negatif yönden gelen nem ve su sızıntılarına karşı korunmasında,
- Beton elemanlarının, yer altı sularının taşıdığı korozif ve zararlı tuzların etkilerine karşı korunmasında,
- Temeller, ıslak hacimler, tüneller, yer altı garajları ve teras bahçelerinin yalıtımında,
- Mutfak, balkon ve tuvalet gibi ıslak hacimlerde fayans altı uygulamalarda kullanılır.



VERPACKUNG / PACKAGING / AMBALAJ

20 Kg.

Kraftbeutel / Kraft Bag / Kraft Torba

TECHNISCHE SPEZIFIKATIONEN / TECHNICAL SPECIFICATIONS / TEKNİK ÖZELLİKLERİ

Farbe / Colour / Renk	Grau/Grey/Gri
Anfangsfestigkeit / Initial strength / Başlangıç dayanımı	> 50 N/mm ²
Biegefestigkeit / Bending strength / Eğilme dayanımı	> 10 N/mm ²
Haftkraft / Adhesion strength / Yapışma dayanımı	> 1,5 N/mm ²
Kapillare Wasseraufnahme / Capillary Water Absorption / Kapiler Su Emme	≥ 0,1 kg/m ² ·h0.5
Reaktion auf Feuer / Reaction to fire / Yangına tepki	A1



KRK BAUSTOFFE

"Geheimnis der Meister"

KRK-K202K

- Zweikomponenten negativ und positiv kristallisiert
- Two-Component Negative and Positive-Crystallized
- İki Bileşenli Negatif ve Pozitif-Kristalize



Es ist ein zweikomponentiges, kapillar wirksames Abdichtungsmaterial auf Zement- und Acrylbasis, das auf Betonoberflächen von innen oder außen, aus negativen und positiven Richtungen, gegen Leckagen und Oberflächenwasser aufgetragen werden kann.

EINSATZBEREICHE:

- Innen- und Außenanwendungen, vertikale und horizontale Anwendungen,
- In Nassbereichen wie WC, Bad, Küche und Balkon, • Fundament- und Vorhangabdichtung, • In Wassertanks, Tunneln, • In seitlichen olympischen Schwimmbädern, • In der Aufzugsgrube, • In Stahlbetonrohren, • Beim Schutz des Betons vor Wasser, Karbonatisierung und Tausalzen, • In Solebecken, Fischzuchtbecken, • In Nährstoffspeichern, • Es wird zur Isolierung von Blumenbeeten verwendet.



It is a cement and acrylic based, two component, capillary effective waterproofing material that can be applied on concrete surfaces from inside or outside, from negative and positive directions, against leakage and surface water.

USAGE AREAS:

- Indoor and outdoor, vertical and horizontal applications, • In wet areas such as WC, bathroom, kitchen and balcony, • Foundation and curtain waterproofing, • In water tanks, tunnels, • In side olympic swimming pools, • In the elevator pit, • In reinforced concrete pipes, • Protecting the concrete from water, carbonation and deicing salts, • In brine pools, fish breeding pools, • In nutrient stores, • It is used in flower bed insulation.



Çimento ve akrilik esaslı, iki bileşenli, sızıntı ve yüzey sularına karşı beton yüzeyler üzerine içten ya da dıştan, negatif ve pozitif yönden uygulanabilen, kapiler etkili su yalıtım malzemesidir.

KULLANIM ALANLARI:

- İç ve dış mekânlarda, düşey ve yatay uygulamalarda, • WC, banyo, mutfak ve balkon gibi ıslak hacimlerde, • Temel ve perde su yalıtımında, • Su depolarında, tünellerde, • Yan olimpik yüzme havuzlarında, • Asansör çukurunda, • Betonarme borularda, • Beton, su, karbonasyon ve buz çözücü tuzlardan korunmada, • Salamura havuzlarında, balık yetiştirme havuzlarında, • Besin maddesi depolarında, • Çiçeklik yalıtımında kullanılır.



VERPACKUNG / PACKAGING / AMBALAJ

25 Kg.

Kraftbeutel / Kraft Bag / Kraft Torba

8 Kg.

Plastikflasche / Plastic bottle / Plastik Bidon

TECHNISCHE SPEZIFIKATIONEN / TECHNICAL SPECIFICATIONS / TEKNİK ÖZELLİKLERİ

Farbe / Colour / Renk	Staub/Dust/Toz: Grau/Grey/Gri flüssig/Liquid/Sıvı: weiß/White/Beyaz
Haftkraft / Adhesion Strength / Yapışma Dayanımı	≥ 1,5 N/mm ²
Druckwasserbeständigkeit / Pressure water resistance / Basıncılı su dayanımı	7 bar pozitif, 4 bar negativ
Kapillare Wasseraufnahme / Capillary water absorption / Kapiler su emmesi (TS EN 12808-5)	≤ 0,10 gr (4 Stunden später/ hours later/saat sonra)
Temperatur des aufzubringenden Bodens / Temperature of the floor to be applied / Uygulanacak zeminin sıcaklığı	+5 °C +30 °C
Betriebstemperatur / Service Temperature / Servis Sıcaklığı	-20 °C +80 °C
Reifezeit / Maturation time / Olgunlaştırma süresi	3-5 Minute/dakika
Mörtel nutzbare Zeit / Mortar usable time / Harcın kullanılabilme süresi	45 Minute/dakika
Zeit zwischen den Mänteln zu warten / Time to wait between coats / Katlar arasında beklenilmesi gereken süre	Min. 6 Stunde/Hours/Saat

KRK-K202F

- Zweikomponenten negativ und positiv-elastisch kristallisiert
- Two Component Negative and Positive-Elastic Crystallized
- İki Bileşenli Negatif ve Pozitif-Elastik Kristalize



Es ist ein zweikomponentiges, vollflexibles Abdichtungsmaterial (negativ-positiv) auf Zement- und Acrylbasis, das innen oder außen auf Betonoberflächen gegen Leckagen und Oberflächenwasser aufgetragen wird.

EINSATZBEREICHE:

- Im Innen- und Außenbereich, bei vertikalen und horizontalen Anwendungen,
- Auf Terrassen (unter der Voraussetzung, dass die Oberseite bei grauen Farbanwendungen geschützt ist) sollte weiße Farbe an UV-offenen Stellen verwendet werden,
- In weichem Wasser (pH 3 bis pH 7) Lagerbecken in der Textilindustrie,
- in Wassertanks und olympischen Schwimmbädern,
- in Fahrstuhlgruben, • in Nassbereichen wie WC, Bad, Küche und Balkon, • in bewegungs-, vibrations- und teils leichten Bereichen des Grundabdichtungssysteme, • Konstruieren von Beton aus Wasser, Karbonatisierung und Tausalzen, Schutz, • Wird in Einrichtungen wie Spas und Bädern verwendet.



It is a cement and acrylic based, two component, fully flexible waterproofing material (negative-positive) applied internally or externally on concrete surfaces against leakage and surface water.

USAGE AREAS:

- Indoors and outdoors, in vertical and horizontal applications, • In terraces, (on condition that the top is protected in gray color applications) white color should be used in places open to UV, • In soft water (pH 3 to pH 7) storage pools used in the textile industry, • In water tanks and olympic swimming pools, • In elevator pits,
- In wet areas such as WC, bathroom, kitchen and balcony, • In areas sensitive to movement, vibration and slight settlement as a part of the basic waterproofing system, • Construct concrete from water, carbonation and deicing salts. protection,
- It is used in facilities such as spas and baths.

Çimento ve akrilik esaslı, iki bileşenli, sızıntı ve yüzey sularına karşı beton yüzeyler üzerine içten ya da dıştan uygulanan, (negatif-pozitif) tam esnek su yalıtım malzemesidir.



KULLANIM ALANLARI:

- İç ve dış mekanlarda, düşey ve yatay uygulamalarda, • Teraslarda, (gri renk uygulamalarda üzeri korunmak şartı ile) UV'ye açık yerlerde beyaz renk kullanılmalıdır, • Tekstil endüstrisinde kullanılan yumuşak su (pH 3 ile pH 7 arası) depolama havuzlarında, • Su depolarında ve olimpik yüzme havuzlarında, • Asansör çukurlarında, • WC, banyo, mutfak ve balkon gibi ıslak hacimlerde, • Temel su yalıtım sisteminin bir parçası olarak harekete, titreşime ve hafif oturmalara duyarlı alanlarda, • Beton, su, karbonasyon ve buz çözücü tuzlardan korumada, • Kaplıca ve hamam gibi tesislerde kullanılır.



VERPACKUNG / PACKAGING / AMBALAJ

25 Kg.

Kraftbeutel / Kraft Bag / Kraft Torba

8 Kg.

Zinn / Tin / Teneke

TECHNISCHE SPEZIFIKATIONEN / TECHNICAL SPECIFICATIONS / TEKNİK ÖZELLİKLERİ

Farbe / Colour / Renk	Staub/Dust/Toz: Grau/Grey/Gri flüssig/liquid/Sıvı: weiß/White/Beyaz
Haftkraft / Adhesion Strength / Yapışma Dayanımı	≥ 1 N/mm ²
Druckwasserbeständigkeit / Pressure water resistance / Basıncılı su dayanımı	2 bar pozitif, 1,5 bar pozitif
Kapillare Wasseraufnahme / Capillary water absorption / Kapiler su emmesi (TS EN 12808-5)	≤ 0,10 gr (4 Stunden später/ hours later/saat sonra)
Temperatur des aufzubringenden Bodens / Temperature of the floor to be applied / Uygulanacak zeminin sıcaklığı	+5 °C +30 °C
Betriebstemperatur / Service Temperature / Servis Sıcaklığı	-20 °C +80 °C
Reifezeit / Maturation time / Olgunlaştırma süresi	3-5 Minute/dakika
Mörtel nutzbare Zeit / Mortar usable time / Harcin kullanılabilme süresi	2 Stunde/Hours/Saat
Zeit zwischen den Mänteln zu warten / Time to wait between coats / Katlar arasında beklenilmesi gereken süre	Min. 12 Stunde/Hours/Saat



KRK BAUSTOFFE

"Geheimnis der Meister"

KRK-ABK

- Abdichtendes Betonzusatzmittel auf kristallisierter Basis
- Crystallized Based Waterproofing Concrete Admixture
- Kristalize Esaslı Su Yalıtım Beton Katkısı



Es handelt sich um ein kristallisiertes, reaktives, wasserundurchlässiges Betonzusatzmittel, das keine zement- und sandbasierten Füllstoffe der 4. Generation enthält, sondern speziell konzentrierte Polymere enthält. Es wurde entwickelt, um die wasserdichten Eigenschaften von Beton zu verbessern und Schwindrisse zu reduzieren.

EINSATZBEREICHE:

- Herstellung von Fundamenten und Vorhängen • Tunnelschutzbetone
- Unterirdische Unterstände und Lagerhallen • Stahlbetonkonstruktionen, die chemischen Einflüssen ausgesetzt sind • Schwimmbecken
- Vorgespannte Fertigbauteile • Klär- und Wasseraufbereitungsanlagen
- Verdeckte Vorrattanks und Wassertanks



It is a crystallized-based, reactive, water-impermeable concrete admixture that does not contain cement and sand-based fillers of the 4th generation, but contains specially concentrated polymers. It is designed to be effective in increasing the waterproofing properties of concrete and reducing shrinkage cracks.

USAGE AREAS:

- Foundation and curtain manufacturing • Tunnel protection concretes
- Underground shelters and warehouses • Reinforced concrete structures exposed to chemical effects • Swimming pools • Prestressed precast structural elements • Sewage and water treatment plants • Concealed reservoir tanks and water tanks



4. Jenarasyon, çimento ve kum esaslı dolgular içermeyen, özel konsantre edilmiş polimerler içeren, kristalize esaslı, reaktif, su geçirimsizliği sağlayan beton katkısıdır. Betonun su geçirmezlik özelliklerini artırmak ve büzülmeyle oluşan çatlakları azaltma konularında etkili olmak üzere tasarlanmıştır.

KULLANIM ALANLARI:

- Temel ve perde imalatları • Tünel koruma betonları • Yer altı sığınak ve depoları • Kimyasal etkilere maruz betonarme yapılar • Yüzme havuzları • Ön germeli prekast yapı elemanları • Kanalizasyon ve su arıtma tesisleri • Gömme rezervuar tankları ve su depoları



VERPACKUNG / PACKAGING / AMBALAJ

20 Kg.

Kraftbeutel / Kraft Bag / Kraft Torba

TECHNISCHE SPEZIFIKATIONEN / TECHNICAL SPECIFICATIONS / TEKNİK ÖZELLİKLERİ

Struktur des Materials / Structure of the material / Malzemenin yapısı	Mineralfüllungen und Natursteine / Mineral fills and Natural rocks / Mineral dolgular ve Doğal kayalar
Farbe / Colour / Renk	Grau/Grey/Gri
Druckfestigkeit / Compressive strength / Basınç dayanımı -C30/37	TSE EN 12390-1-2-3
28 Tag/Day/Gün (Zeuge/Witness/Şahit - 40 N/mm ²)	39,6 N/mm ²
Auftragsstärke / Application thickness / Uygulama kalınlığı	Min. 25 cm
Anzuwendende Lufttemperatur / Air Temperature to be Applied / Uygulanacak Hava Sıcaklığı	wie Beton / same as concrete / Beton ile aynı
Druckwasserdurchlässigkeit / Pressurized Water Permeability / Basınçlı Su Geçirimsizliği	TSE EN 12390-8
35 Tag/Day/Gün Min. Max.	12 mm

KRK-LKT

- Kristallisierte, wasserfeste, flüssige Betonzusatzmittel
- Crystallized Waterproofing Liquid Concrete Admixture
- Kristalize Su Yalıtım Likit Beton Katkısı

 Mit speziell konzentrierten Polymeren der 4. Generation
Es ist ein kristallisiertes, reaktives, wasserundurchlässiges flüssiges
Betonzusatzmittel.

EINSATZBEREICHE:

- Herstellung von Fundamenten und Vorhängen
- Tunnelschutzbetone
- Unterirdische Unterstände und Lagerhallen
- Stahlbetonkonstruktionen, die chemischen Einflüssen ausgesetzt sind
- Schwimmbecken
- Vorgespannte Fertigbauteile
- Klär- und Wasseraufbereitungsanlagen
- Verdeckte Vorrattanks und Wassertanks

 Containing 4th generation, specially concentrated polymers
It is a crystallized based, reactive, water impermeable liquid concrete
admixture.

USAGE AREAS:

- Foundation and curtain manufacturing
- Tunnel protection concretes
- Underground shelters and warehouses
- Reinforced concrete structures exposed to chemical effects
- Swimming pools
- Prestressed precast structural elements
- Sewage and water treatment plants
- Concealed reservoir tanks and water tanks

 4. jenerasyon, özel konsantre edilmiş polimerler içeren
kristalize esaslı, reaktif, su geçirimsizliği sağlayan likit beton katkısıdır.

KULLANIM ALANLARI:

- Temel ve perde imalatları
- Tünel koruma betonları
- Yer altı sığınak ve depoları
- Kimyasal etkilere maruz betonarme yapılar
- Yüzme havuzları
- Ön germeli prekast yapı elemanları
- Kanalizasyon ve su arıtma tesisleri
- Gömme rezervuar tankları ve su depoları



VERPACKUNG / PACKAGING / AMBALAJ

30 Kg.

Trommel / Drum / Bidon

TECHNISCHE SPEZIFIKATIONEN / TECHNICAL SPECIFICATIONS / TEKNİK ÖZELLİKLERİ

Struktur des Materials / Structure of the material / Malzemenin yapısı	Spezialpolymere und Additive / Special polymers and additives / Özel polimerler ve katkılar
Farbe / Colour / Renk	Grau/Grey/Gri
Druckfestigkeit / Compressive strength / Basınç dayanımı -C30/37	TSE EN 12390-1-2-3
28 Tag/Day/Gün (Zeuge/Witness/Şahit - 40 N/mm ²)	39,6 N/mm ²
Auftragsstärke / Application thickness / Uygulama kalınlığı	Min. 25 cm
Anzuwendende Lufttemperatur / Air Temperature to be Applied / Uygulanacak Hava Sıcaklığı	wie Beton / same as concrete / Beton ile aynı
Druckwasserdurchlässigkeit / Pressurized Water Permeability / Basınçlı Su Geçirimsizliği	TSE EN 12390-8
35 Tag/Day/Gün Min. Max.	12 mm



KRK BAUSTOFFE

"Geheimnis der Meister"

KRK-BMX

- Bitumenbasiertes, flexibles Zweikomponenten-Dichtungsmaterial
- Bitumen Based Two Component Flexible Waterproofing Material
- Bitüm Esaslı İki Bileşenli Esnek Su Yalıtım Malzemesi

 Polymermodifizierter Bitumenkautschuk basierend, faserverstärkt, zweikomponentige, elastische, dicke Abdichtungsbeschichtung.

EINSATZBEREICHE:

- Auf Fundament und Vorhangfassaden
- In Nassbereichen, Stützmauern
- Schutz von Bauwerken und Bauteilen, die Sickerwasser, vorübergehendem oder dauerhaftem Wasserdruck ausgesetzt sind und Isolierung
- Kann bei der Verklebung von Dämm- und Drainageplatten eingesetzt werden.
- Da es sich nicht um ein UV-beständiges Produkt handelt, sollte es nach dem Auftragen gut abgedeckt werden.

 Polymer modified bitumen rubber based, fiber reinforced, two component, elastic, thick waterproofing coating.

USAGE AREAS:

- On foundation and curtain walls
- In wet areas, retaining walls
- Protection of structures and structural elements exposed to leachate, temporary or permanent water pressure and insulation
- It can be applied in the bonding of insulation and drainage boards.
- Since it is not a UV resistant product, it should be covered properly after application.

 Polimer modifiye bitüm kauçuk esaslı, elyaf takviyeli çift bileşenli, elastik, kalın su yalıtım kaplaması.

KULLANIM ALANLARI:

- Temel ve perde duvarlarda
- Islak mekânlarda, istinat duvarlarında
- Sızıntı suyuna, geçici veya sürekli su basıncına maruz kalan yapı ve yapı elemanlarının korunması ve yalıtımında
- Yalıtım ve drenaj amaçlı levhaların yapıştırılmasında uygulanabilir.
- UV dayanımlı bir ürün olmadığı için uygulama sonrası üzeri uygun şekilde kapatılmalıdır.



VERPACKUNG / PACKAGING / AMBALAJ

30 Kg. (22+8)

Plastik eimer / Plastic bucket / Plastik Kova

TECHNISCHE SPEZIFIKATIONEN / TECHNICAL SPECIFICATIONS / TEKNİK ÖZELLİKLERİ

Definition / Tanım	Gummi- und Polymermodifizierte Bitumenemulsion / Rubber and Polymer Modified Bitumen Emulsion / Kauçuk ve Polimer Modifiye Bitüm Emülsiyon
Farbe / Colour / Renk	Braun (Schwarz im trockenen Zustand)/Brown (Black When Dry)/Kahverengi (Kuruynunca Siyah)
Konsistenz / Consistency / Kıvam	Pinsel, Kelle, Spray / brush, trowel, spray / Firça, mala, sprej
Fester Inhalt / Solid Content / Katı Madde İçeriği	A: 55% - A+B: 65%
Anwendungstemperatur / Application Temperature / Uygulama Sıcaklığı	+5 °C ile +30 °C
Nutzungszeitraum / Usage Period / Kullanım Süresi	1-2 Stunde/Hours/Saat
Trockenzeit/ Drying Time / Kuruma Süresi	Min. 24 Stunde/Hours/Saat
Kontakt mit Wasser / Contact with water / Su ile Temas	48 Stunde/Hours/Saat

- Bu değerler +23±2 °C sıcaklık ve %50±5 bağıl nemli ortam koşulları için verilmiştir.

KRK-BMX2K

- Faserverstärkt auf Bitumenkautschukbasis
- Bitumen Rubber Based Fiber Reinforced
- Bitüm Kauçuk Esaslı Elyaf Takviyeli

 Polymermodifizierter Bitumenkautschuk basierend, zweikomponentige, elastische, dicke Abdichtungsbeschichtung.

EINSATZBEREICHE:

- Auf Fundament und Vorhangfassaden
- In Nassbereichen, Stützmauern
- Beim Schutz und der Isolierung von Gebäuden und Bauteilen, die Sickerwasser, temporärem oder permanentem Wasserdruck ausgesetzt sind
- Kann bei der Verklebung von Dämm- und Drainageplatten eingesetzt werden.
- Da es sich nicht um ein UV-beständiges Produkt handelt, sollte es nach dem Auftragen ordnungsgemäß abgedeckt werden.

 Polymer modified bitumen rubber based, two component, elastic, thick waterproofing coating.

USAGE AREAS:

- On foundation and curtain walls
- In wet areas, retaining walls
- In the protection and insulation of buildings and building elements exposed to leakage water, temporary or permanent water pressure
- It can be applied in the bonding of insulation and drainage boards.
- Since it is not a UV resistant product, it should be covered properly after application.

 Polimer modifiye bitüm kauçuk esaslı, çift bileşenli, elastik, kalın su yalıtım kaplaması.

KULLANIM ALANLARI:

- Temel ve perde duvarlarda
- Islak mekânlarda, istinat duvarlarında
- Sızıntı suyuna, geçici veya sürekli su basıncına maruz kalan yapı ve yapı elemanlarının korunması ve yalıtımında
- Yalıtım ve drenaj amaçlı levhaların yapıştırılmasında uygulanabilir.
- UV dayanımlı bir ürün olmadığı için uygulama sonrası üzeri uygun şekilde kapatılmalıdır.



VERPACKUNG / PACKAGING / AMBALAJ

30 Kg. (22+8)

Plastik eimer / Plastic bucket / Plastik Kova

TECHNISCHE SPEZIFIKATIONEN / TECHNICAL SPECIFICATIONS / TEKNİK ÖZELLİKLERİ

Definition / Tanım	Gummi- und Polymermodifizierte Bitumenemulsion / Rubber and Polymer Modified Bitumen Emulsion / Kauçuk ve Polimer Modifiye Bitüm Emülsiyon
Farbe / Colour / Renk	Braun (Schwarz im trockenen Zustand)/Brown (Black When Dry)/Kahverengi (Kuruyunca Siyah)
Konsistenz / Consistency / Kıvam	Pinsel, Kelle, Spray / brush, trowel, spray / Fırça, mala, sprej
Fester Inhalt / Solid Content / Katı Madde İçeriği	A: 56% - A+B: 66%
Anwendungstemperatur / Application Temperature / Uygulama Sıcaklığı	+5 °C ile +30 °C
Nutzungszeitraum / Usage Period / Kullanım Süresi	1-2 Stunde/Hours/Saat
Trockenzeit/ Drying Time / Kuruma Süresi	Min. 24 Stunde/Hours/Saat
Kontakt mit Wasser / Contact with water / Su ile Temas	48 Stunde/Hours/Saat

- Bu değerler +23±2 °C sıcaklık ve %50±5 bağıl nemli ortam koşulları için verilmiştir.



KRK BAUSTOFFE

"Geheimnis der Meister"

KRK-M2K

- Vielseitig flexibel einsetzbar anstelle von Zweikomponentenbitumen
- Versatile Flexible Used Instead of Two Component Bitumen
- İki Bileşenli Bitüm Yerine Kullanılan Çok Yönlü Esnek

 Es ist ein vielseitiges flexibles Abdichtungsmaterial, das anstelle von bituminösen und zementbasierten Beschichtungen verwendet werden kann.

EINSATZBEREICHE:

- Gebäudefundamente, Vorhangfassaden, Parkdecks,
- Balkon, Terrasse, Schwimm- und Zierbecken,
- In Nassbereichen unter Keramik im Innen- und Außenbereich,
- Am Übergang von Mauer und Beton
- In Horizontalsperren gegen Feuchtigkeit
- In Kläranlagen
- Wird dort eingesetzt, wo eine schnelle Aushärtung erforderlich ist.

 It is a versatile flexible waterproofing material that can be used instead of bituminous and cement based coatings.

USAGE AREAS:

- Building foundations, curtain walls, car park tops,
- Balcony, terrace, swimming and ornamental pools,
- In wet areas under ceramics in indoor and outdoor areas,
- At the junction of brick wall and concrete
- In horizontal barriers against moisture
- In waste water treatment plants
- It is used where fast curing is required.

 İki Bileşenli, bitümlü ve çimento esaslı kaplamalar yerine kullanılabilen, çok yönlü esnek su yalıtım malzemesidir.

KULLANIM ALANLARI:

- Bina temellerinde, perde duvarlarda, otopark üstlerinde,
- Balkon, teras, yüzme ve süs havuzlarında,
- Kapalı ve açık alanlarda seramik altında ıslak hacimlerde,
- Tuğla duvar ile betonun birleştiği yerdelerde
- Neme karşı yatay bariyerlerde
- Atık su arıtma tesislerinde
- Hızlı kürlenme ihtiyacı olan yerlerde kullanılır.



VERPACKUNG / PACKAGING / AMBALAJ

25 Kg.

Plastik eimer / Plastic bucket / Plastik Kova
(15 Kg. Pulverkomponente/powder component/toz bileşen

10 Kg. flüssige Komponente/ liquid component/sıvı bileşen)

TECHNISCHE SPEZIFIKATIONEN / TECHNICAL SPECIFICATIONS / TEKNİK ÖZELLİKLERİ

Aussehen / Appearance / Görünüm	Paste / Macun
Betriebszeit / Operation time / Çalışma Süresi	30-60 Minute / Dakika
Trockenzeit/ Drying Time / Kuruma Süresi	18-20 Stunde/Hours/Saat (5°C/%70 relative Luftfeuchtigkeit/relative humidity/bağıl nem)
Fester Inhalt / Solid Content / Su Geçirmezlik	bis 10m / up to 10 m / 10 m'ye kadar
Anwendungstemperatur / Application Temperature / Taze Harç Yoğunluğu	1,1 kg/dm ³
Trockenzeit/ Drying Time / Çatlak Köprüleme	3mm
Kontakt mit Wasser / Katman Kalınlığı	1,1 mm dicke Nassschicht ca. 1 mm Trockenschicht / 1.1 mm thick wet layer approx. 1 mm dry layer / 1.1 mm kalınlığında ıslak tabaka yaklaşık 1 mm kuru tabaka
Su Buharı Difüzyon direnç katsayısı	~6600

KRK-ELS

- UV-beständiges, superelastisches Elastomer auf Harzbasis
- Elastomeric Resin Based UV Resistant Super Elastic
- Elastomerik Reçine Esaslı UV Dayanımlı Süper Elastik

 Es ist ein UV-beständiges, einkomponentiges, gebrauchsfertiges Abdichtungsmaterial auf Elastomerharzbasis.

EINSATZBEREICHE:

- In Betonbächen,
- In Zink- und Fertigteilströmen,
- Auf schrägen Terrassendächern,
- Am Elevatorbecher,
- Im Außenbereich.

 It is an elastomeric resin-based, UV-resistant, single-component, ready-to-use waterproofing material.

USAGE AREAS:

- In concrete streams,
- In zinc and precast streams,
- On sloping terrace roofs,
- On the elevator bucket,
- On exteriors.

 Elastomerik reçine esaslı, UV ışınlarına dayanıklı, tek bileşenli, kullanıma hazır su yalıtım malzemesidir.

KULLANIM ALANLARI:

- Beton derelerde ,
- Çinko ve prekast derelerde ,
- Meyilli teras çatılarda ,
- Asansör kovası üzerinde,
- Dış cephelerde.



VERPACKUNG / PACKAGING / AMBALAJ

5 und-and-ve 20 Kg.

Plastik eimer / Plastic bucket / Plastik Kova

TECHNISCHE SPEZIFIKATIONEN / TECHNICAL SPECIFICATIONS / TEKNİK ÖZELLİKLERİ

Aussehen / Appearance / Görünüm	Farbkuchen / Color Cake / Renkli Pasta
Farbe / Colour / Renk	Hellgrau / Light grey / Açık Gri
Intensität / Intensity / Yoğunluk	1,42±0,02 kg/m ³
pH	9.0 - 10.0
Feste Materie / Solid Matter / Katı Madde	% 66±2
Viskosität / Viscosity / Viskozite	7000-10000 cpoise
Shore A Härte / Shore A Hardness / Sertliği	70
Haftfestigkeit auf Beton / Adhesion Strength to Concrete / Betona Yapışma Dayanımı	>1,5 N/mm ²
Bruchdehnung / Elongation at Break / Kopmada Uzama	%250
Wasserdampfdurchlässigkeit / Water Vapor Permeability / Su Buharı Geçirgenliği	Klasse/Class/Sınıf 1 (0.7m)
Wasseraufnahme / Water Absorption / Su Emme	< 0,1 kg/m ² .h0.5
Tippen Sie auf Trockenzeit / Touch Dry Time / Dokunma Kuruma Süresi	1-2 Stunde/Hours/Saat
Vollständige Trocknungszeit / Full Drying Time / Tam Kuruma Süresi 20°C	48 Stunde/Hours/Saat



KRK BAUSTOFFE

"Geheimnis der Meister"

KRK-KFLEX

- Einkomponenten-Superelastische auf Polyurethanbasis
- Polyurethane Based Single Component Super Elastic
- Poliüretan Esaslı Tek Bileşenli Süper Elastik

 Einkomponentige, superelastische, wasserbasierte Imprägnierbeschichtung auf Polyurethanbasis. Es härtet mit der Luftfeuchtigkeit aus und bildet einen elastischen und haltbaren Film.

EINSATZBEREICHE:

- Terrassen, Veranden und Balkone, • Bereiche unter dem Bürgersteig (Nassbereiche, Badezimmer) • Parkplätze, • Anwendungsbereiche im Innen- und Außenbereich, • Dächer, die nicht bedeckt sind, • Brückenplattformen, • Bei vertikalen und horizontalen Anwendungen, • In Fundamentdämmungen, Garagen, Unterführungen und unterirdischen Lagerhallen, Nassbereichen • auf Terrassen, Terrassengärten und -dächern, Balkonen (sofern überdacht),

 One component, polyurethane based, super elastic, water based waterproofing coating. It cures with moisture in the air, forming an elastic and durable film.

USAGE AREAS:

- Terraces, Verandas and Balconies, • Areas under pavement (Wet Areas, Bathrooms) • Parking lots, • Interior and exterior application areas, • Roofs that are not covered, • Bridge platforms, • In vertical and horizontal applications, • In foundation insulation, Garages, underpasses and underground warehouses, wet areas • On terraces, terrace gardens and roofs, balconies (provided that they are covered),

 Tek bileşenli, poliüretan esaslı, süper elastik, su bazlı su yalıtım kaplaması. Havadaki nem ile kürlenerek elastik ve dayanıklı bir film oluşturur.

KULLANIM ALANLARI:

- Teraslar, Verandalar ve Balkonlar, • Kaplama altı alanlar (Islak Hacimler, Banyolar) • Otoparklar, • İç ve Dış uygulama alanları, • Üzeri kapatılmayan çatılar, • Köprü platformları, • Düşeyde ve yatayda yapılan uygulamalarda, • Temel yalıtımında, Teraslarda, alt geçitlerde ve yer altı depolarında, ıslak hacimlerde • Teraslarda, teras bahçe ve çatılarda, balkonlarda (üzeri kaplanmak şartıyla),



VERPACKUNG / PACKAGING / AMBALAJ

20 Kg.

Plastik eimer / Plastic bucket / Plastik Kova

TECHNISCHE SPEZIFIKATIONEN / TECHNICAL SPECIFICATIONS / TEKNİK ÖZELLİKLERİ

Definition / Tanım	Einkomponenten-Polyurethanbeschichtung / One Component Polyurethane Coating / Tek Bileşenli Poliüretan Kaplama
Farbe / Colour / Renk	Schwarz / Black / Siyah
Intensität / Intensity / Yoğunluk	1,25gr/m ³
Wasserdampfdurchlässigkeit / water vapor permeability / Su Buharı Geçirgenliği	0,5 gr/m ²
Viskosität / Viscosity / Viskozite	8000 cp
Shore A Härte / Shore A Hardness / Sertliği	65-70
Haftfestigkeit auf Beton / Adhesion Strength to Concrete / Betona Yapışma Dayanımı	>1,5 N/mm ²
Bruchdehnung / Elongation at Break / Kopmada Uzama	%400
Anwendungstemperatur / Application Temperature / Uygulama Sıcaklığı	+5 °C ile +30 °C
Vollständige Trocknungszeit / Full Drying Time / Tam Kuruma Süresi 23°C	24 Stunde/Hours/Saat

KRK-KR

- UV-beständiges, superelastisches, reines Harz auf Polyurethanbasis
- Pure Resin Polyurethane Based UV Resistant Super Elastic
- Saf Reçine Poliüretan Esaslı UV Dayanımlı Süper Elastik

 Es handelt sich um eine einkomponentige, kostengünstige, elastische Flüssigmembran auf Polyurethanbasis für Abdichtungs- und Schutzzwecke. Es härtet mit der Luftfeuchtigkeit aus und bildet einen elastischen und haltbaren Film.

EINSATZBEREICHE:

- Gips- und Zementplatten,
- Anwendungsbereiche im Innen- und Außenbereich,
- Überdachte Dächer,
- Nassbereiche,
- Badezimmer,
- Bereiche unter Beschichtung,
- Asphaltbahnen,

 It is a single component, polyurethane based, economical elastic liquid membrane for waterproofing and protection purposes. It cures with moisture in the air, forming an elastic and durable film.

USAGE AREAS:

- Gypsum and cement panels,
- Interior and exterior application areas,
- Covered roofs,
- Wet areas,
- Bathrooms,
- Areas under coating,
- Asphalt membranes,

 Tek bileşenli, poliüretan esaslı, su yalıtım ve koruma amaçlı, ekonomik elastik sıvı membrandır. Havadaki nem ile kürlenerek elastik ve dayanıklı bir film oluşturur.

KULLANIM ALANLARI:

- Alçı ve çimento paneller, • İç ve dış uygulama alanları,
- Üzeri kapatılan çatılar, • Islak hacimler, • Banyolar,
- Kaplama altı alanlar, • Asfalt membranlar,



VERPACKUNG / PACKAGING / AMBALAJ

25 Kg.

Plastik eimer / Plastic bucket / Plastik Kova

TECHNISCHE SPEZIFIKATIONEN / TECHNICAL SPECIFICATIONS / TEKNİK ÖZELLİKLERİ

Definition / Tanım	Einkomponenten-Polyurethan / One Component Polyurethane / Tek Bileşenli Poliüretan
Farbe / Colour / Renk	Grau weiß / Grey-White / Gri-Beyaz
Intensität / Intensity / Yoğunluk	1,43 gr/cm ³ ±0.05
Wasserdampfdurchlässigkeit / water vapor permeability / Su Buharı Geçirgenliği	0,8 gr/m ² / Stunde/Hours/Saat
Viskosität / Viscosity / Viskozite	3000-5000 cp
Shore A Härte / Shore A Hardness / Sertliği	60
Haftfestigkeit auf Beton / Adhesion Strength to Concrete / Betona Yapışma Dayanımı	>2 N/mm ²
Bruchdehnung / Elongation at Break / Kopmada Uzama	≥ %400
Anwendungstemperatur / Application Temperature / Uygulama Sıcaklığı	+5 °C ile +35 °C
Vollständige Trocknungszeit / Full Drying Time / Tam Kuruma Süresi 23°C	7 Tag/Day/Gün



KRK BAUSTOFFE

"Geheimnis der Meister"

KRK-KRF

- Einkomponenten-Polyurethan-Basis, superelastisch, schnell härtend
- One Component Polyurethane Based, Super Elastic Fast Curing
- Tek Bileşenli Poliüretan Esaslı, Süper Elastik Hızlı Kurlenen

 Einkomponentige, superelastische, UV-beständige, schnell härtende wasserabweisende Beschichtung auf Polyurethanbasis, die mit Luftfeuchtigkeit aushärtet und einen elastischen und dauerhaften Film bildet.

EINSATZBEREICHE:

- Bewässerungskanäle, • Terrassen, Veranden und Balkone,
- Bereiche unter dem Bürgersteig (Nassbereiche, Badezimmer)
- Parkplätze, • Gips- und Zementplatten,
- Anwendungsbereiche im Innen- und Außenbereich,
- Dächer, die nicht bedeckt sind, • Brückenplattformen,
- Asphaltbahnen, • Stadiontribünen.

 One component, polyurethane based, super elastic, UV resistant, fast curing waterproofing coating. It cures with the humidity in the air, forming an elastic and durable film.

USAGE AREAS:

- Irrigation channels, • Terraces, Verandas and Balconies,
- Areas under pavement (Wet Areas, Bathrooms)
- Parking lots, • Gypsum and cement panels,
- Interior and exterior application areas,
- Roofs that are not covered, • Bridge platforms,
- Asphalt membranes, • Stadium bleachers.

 Tek bileşenli, poliüretan esaslı, süper elastik, Uv dayanımlı hızlı kür özelliğine sahip su yalıtım kaplaması. Havadaki nem ile kürlenerek elastik ve dayanıklı bir film oluşturur.

KULLANIM ALANLARI:

- Sulama kanalları, • Teraslar, Verandalar ve Balkonlar, • Kaplama altı alanlar (Islak Hacimler, Banyolar) • Otoparklar, • Alçı ve çimento paneller, • İç ve Dış uygulama alanları, • Üzeri kapatılmayan çatılar, • Köprü platformları, • Asfalt membranlar, • Stadyum tribünleri.



VERPACKUNG / PACKAGING / AMBALAJ

25 Kg.

Metalleimer / Metal Bucket / Metal Kova

TECHNISCHE SPEZIFIKATIONEN / TECHNICAL SPECIFICATIONS / TEKNİK ÖZELLİKLERİ

Definition / Tanım	Einkomponenten-Polyurethan / One Component Polyurethane / Tek Bileşenli Poliüretan
Farbe / Colour / Renk	Grau weiß / Grey-White / Gri-Beyaz
Intensität / Intensity / Yoğunluk	1,40 gr/cm ³ ±0.05
Wasserdampfdurchlässigkeit / water vapor permeability / Su Buharı Geçirgenliği	0,8 gr/m ² /
Viskosität / Viscosity / Viskozite	2500-3500 cp
Shore A Härte / Shore A Hardness / Sertliği	70
Haftfestigkeit auf Beton / Adhesion Strength to Concrete / Betona Yapışma Dayanımı	>2 N/mm ²
Bruchdehnung / Elongation at Break / Kopmada Uzama	%600
Anwendungstemperatur / Application Temperature / Uygulama Sıcaklığı	+5 °C ile +35 °C
Vollständige Trocknungszeit / Full Drying Time / Tam Kuruma Süresi 23°C	7 Tag/Day/Gün

KRK-KRPB

- Super elastisch auf Polyurethan-Bitumen-Basis
- Polyurethane-Bitumen Based Super Elastic
- Poliüretan-Bitüm Esaslı Süper Elastik

 Es handelt sich um eine zweikomponentige, auf Polyurethan basierende und bitumenhaltige, schnell härtende, elastische, kalt aufgetragene Flüssigmembran. Es bildet einen hochelastischen Film, indem es auf fast allen Oberflächen, auf denen es aufgetragen wird, perfekt haftet.

EINSATZBEREICHE:

- Wassertanks (ohne Trinkwassertanks), • Fußböden, • Fundamente, • Brückenplattformen, • Tunnel in offener Bauweise, • Wird unter Fliesen in Bädern, Terrassen und Dächern eingesetzt. • Betonkonstruktionen, • Stützmauern, • Gips- und Zementplatten, • EPDM-Membranen. • Asphaltmembranen. • Gründächer und Pflanzbeete • Leichtdächer (aus Metall oder Faserzement)

 It is a two component, polyurethane based and bitumen containing fast curing, elastic, cold applied liquid membrane. It forms a highly elastic film by adhering perfectly to almost any surface on which it is applied.

USAGE AREAS:

- Water tanks (excluding drinking water tanks), • Floors, • Foundations, • Bridge platforms, • Cut-and-cover tunnels, • It is applied under tiles in bathrooms, terraces and roofs. • Concrete structures, • Retaining walls, • Gypsum and cement panels, • EPDM membranes. • Asphalt membranes. • Green roofs and plant beds • Lightweight roofs (made of metal or fiber cement)

 İki bileşenli, poliüretan esaslı ve bitüm ihtiva eden hızlı kürleneyen, elastik, soğuk uygulanan sıvı membrandır. Uygulandığı hemen her türlü yüzeye mükemmel yapışarak yüksek elastikliğe sahip bir film oluşturur.

KULLANIM ALANLARI:

- Su tankları (içme suyu depoları hariç), • Zeminler, • Temeller, • Köprü platformları, • Aç-Kapa tüneller, • Banyo, teras ve çatılarda fayans altına uygulanır. • Beton yapılar, • İstinat duvarları, • Alçı ve çimento paneller, • EPDM membranlar. • Asfalt membranlar. • Yeşil çatılar ve bitki tarhları • Hafif çatılar (metal veya lişi çimentodan yapılmı)



VERPACKUNG / PACKAGING / AMBALAJ

40 Kg. (20+20)

Metalleimer / Metal Bucket / Metal Kova

TECHNISCHE SPEZIFIKATIONEN / TECHNICAL SPECIFICATIONS / TEKNİK ÖZELLİKLERİ

Definition / Tanım	Bitumen - Polyurethan / Bitumen - Polyurethane / BitümPoliüretan
Farbe / Colour / Renk	Schwarz / Balck / Siyah
Intensität / Intensity / Yoğunluk	1 gr/cm ³ ±0.02
Mischverhältnis / Mixing ratio / Karışım Oranı	1/1
Viskosität / Viscosity / Viskozite	3000-3500 cp
Shore A Härte / Shore A Hardness / Sertliği	35
Hafffestigkeit auf Beton / Adhesion Strength to Concrete / Betona Yapışma Dayanımı	>2 N/mm ²
Bruchdehnung / Elongation at Break / Kopmada Uzama	≥ %2000
Anwendungstemperatur / Application Temperature / Uygulama Sıcaklığı	+5 °C ile +35 °C
Vollständige Trocknungszeit / Full Drying Time / Tam Kuruma Süresi 23°C	7 Tag/Day/Gün



KR BAUSTOFFE

"Geheimnis der Meister"

KRK-KR210

- Transparenter Einkomponenten-Primer auf Polyurethanbasis
- Polyurethane Based, One Component Transparent Primer
- Poliüretan Esaslı, Tek Bileşenli Şeffaf Astar

 Es ist ein transparentes, einkomponentiges Polyurethan-Grundierungsmaterial.

EINSATZBEREICHE:

- Beton,
- Gips,
- Gipsoberflächen,
- Holz usw.

 It is a transparent, single component, polyurethane primer material.

USAGE AREAS:

- Concrete,
- Plaster,
- Gypsum surfaces,
- Wood etc.

 Şeffaf, tek bileşenli, poliüretan astar malzemesidir.

KULLANIM ALANLARI:

- Beton,
- Sıva,
- Alçı yüzeyler,
- Ahşap vb.



VERPACKUNG / PACKAGING / AMBALAJ

20 Kg.

Metalleimer / Metal Bucket / Metal Kova

TECHNISCHE SPEZIFIKATIONEN / TECHNICAL SPECIFICATIONS / TEKNİK ÖZELLİKLERİ

Definition / Tanım	Einkomponenten-Polyurethan / One Component Polyurethane / Tek Bileşenli Poliüretan
Farbe / Colour / Renk	Transparent / Şeffaf
Intensität / Intensity / Yoğunluk	1,01 gr/cm ³ ±0.03
Viskosität / Viscosity / Viskozite	10-50 cp
Shore A Härte / Shore A Hardness / Sertliği	95
Haftfestigkeit auf Beton / Adhesion Strength to Concrete / Betona Yapışma Dayanımı	>2,2 N/mm ²
Anwendungstemperatur / Application Temperature / Uygulama Sıcaklığı	+5 °C ile +40 °C
Vollständige Trocknungszeit / Full Drying Time / Tam Kuruma Süresi 23°C	4 Tag/Day/Gün

KRK-KR220

- Feuchtigkeittolerante Zweikomponenten-Grundierung auf Polyurethanbasis
- Polyurethane Based, Two Component, Moisture Tolerant Primer
- Poliüretan Esaslı, İki Bileşenli, Nem Toleranslı Astar

 Grundierungsmaterial für feuchtigkeittolerante Zweikomponenten-Dichtungsmaterialien auf Polyurethanbasis.

EINSATZBEREICHE:

- Beton,
- Gips,
- Gipsoberflächen,
- Holz usw.
- Glas-, Metall- und Marmoroberflächen.

 Primer for two-component polyurethane based moisture tolerant waterproofing materials.

USAGE AREAS:

- Concrete,
- Plaster,
- Gypsum surfaces,
- Wood etc.
- Glass, metal and marble surfaces.

 İki bileşenli poliüretan esaslı nem toleranslı su yalıtım malzemeleri için astar malzemesi.

KULLANIM ALANLARI:

- Beton,
- Sıva,
- Alçı yüzeyler,
- Ahşap vb.
- Cam, metal ve mermer yüzeyler.



VERPACKUNG / PACKAGING / AMBALAJ

18 Kg.
Set

TECHNISCHE SPEZIFIKATIONEN / TECHNICAL SPECIFICATIONS / TEKNİK ÖZELLİKLERİ

Definition / Tanım	Einkomponenten-Polyurethanbeschichtung / One Component Polyurethane Coating / Tek Bileşenli Poliüretan Kaplama
Farbe / Colour / Renk	Grau weiß / Grey-White / Gri-Beyaz
Intensität / Intensity / Yoğunluk	1,18 gr/cm ³
Viskosität / Viscosity / Viskozite	200 cp
Shore A Härte / Shore A Hardness / Sertliği	70
Haftfestigkeit auf Beton / Adhesion Strength to Concrete / Betona Yapışma Dayanımı	>4 N/mm ²
Anwendungstemperatur / Application Temperature / Uygulama Sıcaklığı	+5 °C ile +35 °C
Bruchdehnung / Elongation at Break / Kopmada Uzama	%300



KRK BAUSTOFFE

"Geheimnis der Meister"

KRK-EPOOL

- Spezialfarbe auf Epoxidbasis für Trinkwasser und Pools
- Epoxy Based Special Paint for Drinking Water and Pools
- Epoksi Esaslı, İçme Suyu ve Havuzlar İçin Özel Boya

 Es ist ein lösemittelfreier Zweikomponenten-Beschichtungsstoff für Pools und Trinkwassertanks mit hoher mechanischer und chemischer Beständigkeit.

EINSATZBEREICHE:

- In Schwimm- und Zierbecken
- Es wird verwendet, um Korrosion und Verschleiß an Rohren, Tanks und Ausrüstungsbeschichtungen zu verhindern.
- Es wird in Trinkwasserleitungen und Trinkwassertanks verwendet.

 It is a solvent-free, two-component coating material for pools and drinking water tanks with high mechanical and chemical resistance.

USAGE AREAS:

- In swimming pools and ornamental pools
- It is used to prevent corrosion and wear on pipes, tanks and equipment coatings.
- It is used in drinking water pipes and drinking water tanks.

 Solventsiz iki komponentli mekanik ve kimyasal dayanımı yüksek havuzlar ve içme suyu depoları için özel kaplama malzemesidir.

KULLANIM ALANLARI:

- Yüzme havuzları ve süs havuzlarında
- Boru, tank ve ekipman kaplamalarda korozyonu ve aşınmaları önlemek amacı ile kullanılır.
- İçme suyu borularında ve içme suyu tanklarında kullanılır.



VERPACKUNG / PACKAGING / AMBALAJ

12,5 Kg.
Set

TECHNISCHE SPEZIFIKATIONEN / TECHNICAL SPECIFICATIONS / TEKNİK ÖZELLİKLERİ

Intensität / Intensity / Yoğunluk	1,30 ± 0,1 gr/ml
Feststoffmischung (%) / Solids Mixture (%) / Katı Madde Karışımı (%)	100
Anwendungsverdünner / Application Thinner / Uygulama Tineri	Nicht verdünnt / Not thinned / İnceltilemez
Mischverhältnis / Mixing ratio / Karışım Oranı	Nach Ausgabe / By volume / Hacimce : A/B : 3/1
Gemischlebensdauer / Mixture Life / Karışım Ömrü	70 Minute/Dakika /23 °C, 200 g.
Anwendungsmethode / Method of Application / Uygulama Şekli	mit Airless-Pistole / With airless gun / Airless tabanca ile

KRK-EMP

- Wasserbasiertes Imprägniermaterial auf Silan-/Siloxanbasis
- Silane/Siloxane Based Water Based Impregnation Material
- Silan/Siloksan Esaslı Su Bazlı Empenye Malzemesi

 Es handelt sich um ein wasserabweisendes, wasserbasiertes, einkomponentiges, dünnflüssiges, transparentes, gebrauchsfertiges Oberflächenschutzmaterial auf Silan/Siloxan-Basis, das die Bildung von Schmutz auf der aufgetragenen Oberfläche verhindert, waschbar ist und keine Filmschicht bilden.

EINSATZBEREICHE:

• Kufeki-Stein usw. auf saugenden Natursteinoberflächen (Außenwände von Mauerwerkskonstruktionen), • Auf Ziegel- und Fliesenoberflächen (Außenseite von Mauerwerkskonstruktionen), • Auf Fliesen- und Sandsteinoberflächen, • In Porenbeton, Schaumbeton • Ummantelung auf Decklackoberflächen • Auf Mineralputz, • Wird als Hydrophobierungsmittel auf porösen Natursteinoberflächen verwendet.

 It is a silane/siloxane-based, water-repellent, water-based, one-component, low-viscosity, transparent, ready-to-use surface protection material that prevents the formation of dirt on the applied surface, can be washed and does not form a film layer.

USAGE AREAS:

• Kufeki stone etc. on absorbent natural stone surfaces (exteriors of masonry structures), • On brick and tile surfaces (exterior of masonry structures), • On tile surfaces and sandstone surfaces, • In Aerated Concretes, Foam Concretes • Sheathing on topcoat surfaces • On mineral plaster, • It is used as a water repellent on porous natural stone surfaces.

 Silan/Siloksan esaslı, su itici, su bazlı, tek bileşenli, düşük viskoziteli, şeffaf, kullanıma, uygulandığı yüzeyde kir oluşumunu engelleyen, yıkanabilen ve film tabaka oluşturmayan hazır yüzey koruma malzemesidir.

KULLANIM ALANLARI:

• Küfeki taşı vb. emici doğal taş yüzeylerde (yığma yapıların dış cephelerinde), • Tuğla ve kiremit yüzeylerde (yığma yapıların dış cephelerinde), • Karo yüzeylerde ve kumtaşı yüzeylerde, • Gazbetonlarda, Köpük Betonlarda • Mantolama son kat yüzeylerde • Mineral sıva üzerinde, • Gözenekli doğal taş yüzeylerde su itici olarak kullanılır.



VERPACKUNG / PACKAGING / AMBALAJ

30 Kg.

Trommel / Drum / Bidon

TECHNISCHE SPEZIFIKATIONEN / TECHNICAL SPECIFICATIONS / TEKNİK ÖZELLİKLERİ

Chemische Struktur / Chemical structure / Kimyasal Yapı	Lösungsmittelbasiert, Alkyl-Alkoxy-Silan/Siloxan-basiert / Solvent based, Alkyl-Alkoxy-Silane/Siloxane based / Solventlii, Alkil-Alkoksi-Silan/Siloksan esaslı
Farbe / Colour / Renk	Transparent / Şeffaf
Intensität / Intensity / Yoğunluk	1.00±0.01 g/ml
Feste Materie / Solid Matter / Katı Madde	% 3 - 4
Ph	10-11
Flammpunkt / Flash Point / Parlama Noktası	Yanıcı değildir.
Trockenzeit / Drying Time / Kuruma Süresi	Beginnt nach 4 Stunden Wasserbeständigkeit zu zeigen / Starts to show resistance to water after 4 hours / 4 saat sonra suya karşı dayanıklılık göstermeye başlar



WASCHTISCHMISCHER
BASIN MIXERS
MUTFAK LAVABO BATARYALARI

WASCHTISCHMISCHER / BASIN MIXERS / MUTFAK LAVABO BATARYALARI



P415 NINA / CHROM - CHROME - KROM



P515 OPUS / CHROM - CHROME - KROM



P525 VEGA / CHROM - CHROME - KROM



6515 MAY / CHROM - CHROME - KROM



6608 SULTANCE / CHROM - CHROME - KROM

WASCHTISCHMISCHER / BASIN MIXERS / MUTFAK LAVABO BATARYALARI



Länge / Length / Uzunluk: 190 mm
Höhe / Height / Yükseklik: 210 mm

BE11039902 GRACE / HELLES NICKEL - BRIGHT NICKEL - PARLAK NİKEL



Länge / Length / Uzunluk: 200 mm
Höhe / Height / Yükseklik: 285 mm

BE11009407 HERMES / GEBÜRSTETE BRONZE - ROSGOLD
BRUSHED BRONZE - ROSE GOLD / FIRÇALI BRONZ - ROSE GOLD



Länge / Length / Uzunluk: 183 mm
Höhe / Height / Yükseklik: 263 mm

BE11011803 LADO / GEBÜRSTETE BRONZE - BRUSHED BRONZE - FIRÇALI BRONZ



Länge / Length / Uzunluk: 200 mm
Höhe / Height / Yükseklik: 288 mm

BE11012207 LUCCA / ROSGOLD - ROSE GOLD

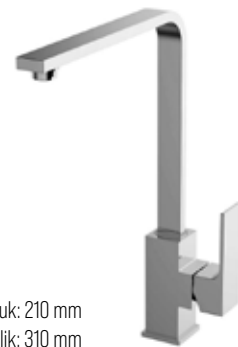

Länge / Length / Uzunluk: 210 mm
Höhe / Height / Yükseklik: 310 mm

BE11007107 FLAT / CHROM - CHROME - KROM

WASCHTISCHMISCHER / BASIN MIXERS / MUTFAK LAVABO BATARYALARI



941881BS AQUA / SCHWARZ/HELLES KUPFER - BLACK/BRIGHT COPPER - SİYAH/PARLAK BAKIR



971531SR DOMINO / ROT - RED - KIRMIZI



130535 ELITE / BRONZE - BRONZ



891921 ENERGY SPIRAL / CHROM - CHROME - KROM



104531 HEXA / CHROM - CHROME - KROM



BAD WASSERHAHN
BATH FAUCET
BANYO BATARYALARI

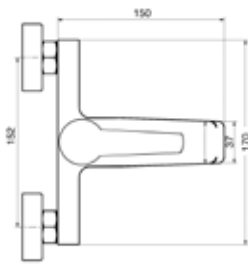

P904 AGENA / CHROM - CHROME - KROM

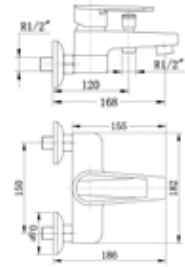

CP504 PARICE / CHROM - CHROME - KROM

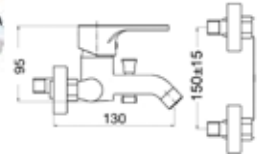

6304 SPICA / CHROM - CHROME - KROM

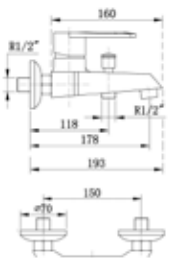

SN204 SUN / CHROM - CHROME - KROM

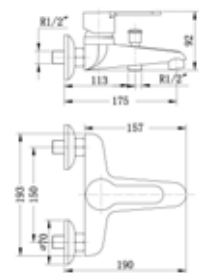

PT804 PORTO / CHROM - CHROME - KROM

BAD WASSERHAHN / BATH FAUCET / BANYO BATARYALARI



Länge / Length / Uzunluk: 189 mm
Handbrauseanschluss / hand shower connection / El duşu bağlantısı: G 1/2"

BB01009405 HERMES / CHROM-ROSGOLD / CHROME-ROSE GOLD /
KROM-ROSEGOLD



Länge / Length / Uzunluk: 174 mm
Handbrauseanschluss / hand shower connection / El duşu bağlantısı: G 1/2"

BB01012102 LUCCA / PLATINIERTES PLATIN
PLATED PLATINUM / KAPLAMA PLATİN



Länge / Length / Uzunluk: 170 mm
Handbrauseanschluss / hand shower connection / El duşu bağlantısı: G 1/2"

BB01044102 SALVO / CHROM - CHROME - KROM

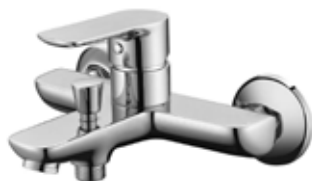

Länge / Length / Uzunluk: 164 mm
Handbrauseanschluss / hand shower connection / El duşu bağlantısı: G 1/2"

BB01017102 TORRES / CHROM - CHROME - KROM



Länge / Length / Uzunluk: 193 mm
Handbrauseanschluss / hand shower connection / El duşu bağlantısı: G 1/2"

BB01011805 LADO / GEBÜRSTETE BRONZE - BRUSHED BRONZE - FIRÇALI BRONZ

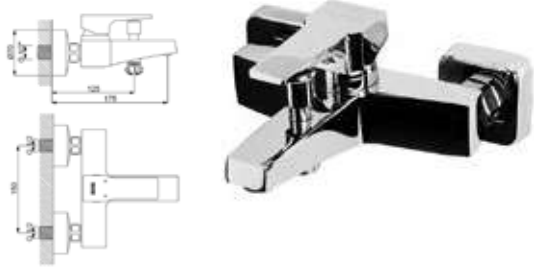

941511 AQUA / CHROM - CHROME - KROM



126511 CLINIC / CHROM - CHROME - KROM



131511 ELITE-X / CHROM - CHROME - KROM



981511 LIFE / CHROM - CHROME - KROM



921511W LOFT / WEISS - WHITE - BEYAZ



**WASSERHAHN
FAUCET
LAVABO BATARYALARI**

WASSERHAHN / FAUCET / LAVABO BATARYALARI



P571 LIBRA / CHROM - CHROME - KROM



1101 HESNA / CHROM - CHROME - KROM



6301 SPICA / CHROM - CHROME - KROM



SN201 SUN / CHROM - CHROME - KROM



P308 OPUS / CHROM - CHROME - KROM

WASCHTISCHMISCHER / BASIN MIXERS / MUTFAK LAVABO BATARYALARI



Länge / Length / Uzunluk: 120 mm
Höhe / Height / Yükseklik: 89 mm

BL11039901 GRACE / HELLES NICKEL - BRIGHT NICKEL - PARLAK NİKEL



Länge / Length / Uzunluk: 130 mm
Höhe / Height / Yükseklik: 109 mm

BL11009401 HERMES / GEBÜRSTETE BRONZE - ROSGOLD
BRUSHED BRONZE - ROSE GOLD / FIRÇALI BRONZ - ROSE GOLD



Länge / Length / Uzunluk: 130 mm
Höhe / Height / Yükseklik: 98 mm

BL11039905 GRACE / HELLES NICKEL - BRIGHT NICKEL - PARLAK NİKEL



Länge / Length / Uzunluk: 135 mm
Höhe / Height / Yükseklik: 103 mm

BL11012206 LUCCA / ROSGOLD - ROSE GOLD



Länge / Length / Uzunluk: 114mm
Höhe / Height / Yükseklik: 103 mm

BL71044108 SALVO / CHROM - CHROME - KROM

WASCHTISCHMISCHER / BASIN MIXERS / MUTFAK LAVABO BATARYALARI



910568 BOLD 3 / GOLD

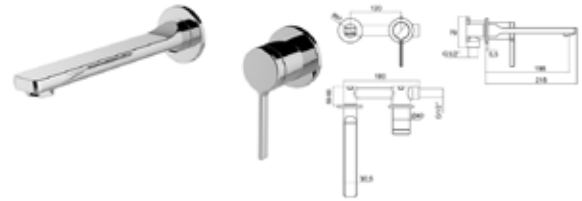

910571 BOLD EINGEBAUT/BUILT-IN/ANKASTRE / CHROM - CHROME - KROM



126521 CLINIC / CHROM - CHROME - KROM



131521 ELITE-X / CHROM - CHROME - KROM



951522 GOLDEN / CHROM - CHROME - KROM



BADE- & DUSCHSYSTEME
BATH & SHOWER SYSTEMS
BANYO & DUŐ SİSTEMLERİ



0499 SCHIEBEN/SLIDING/SÜRGÜLÜ / CHROM - CHROME - KROM

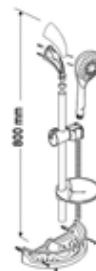

0588 SCHIEBEN/SLIDING/SÜRGÜLÜ / CHROM - CHROME - KROM



2512S SCHIEBEN/SLIDING/SÜRGÜLÜ / CHROM - CHROME - KROM



2513S SCHIEBEN/SLIDING/SÜRGÜLÜ / CHROM - CHROME - KROM

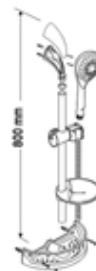

9952 SCHIEBEN/SLIDING/SÜRGÜLÜ / CHROM - CHROME - KROM

BADE- & DUSCHSYSTEME / BATH & SHOWER SYSTEMS / BANYO & DUŞ SİSTEMLERİ



Kopfbrause/ Overhead Shower/ Tepe Duşu: 200 mm
Länge / Length / Uzunluk: 150 mm
Verbindung/ Connection/Bağlantı: G 1/2"
Verstellbare Höhe/ Adjustable Height
/Ayarlanabili Yükseklik

BD44029102 TORRES / CHROM - CHROME - KROM

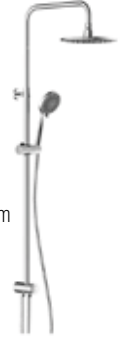

Kopfbrause/ Overhead Shower/ Tepe Duşu: 222 mm
Länge / Length / Uzunluk: 150 mm
Verbindung/ Connection/Bağlantı: G 1/2"
Verstellbare Höhe/ Adjustable Height
/Ayarlanabili Yükseklik

BD44029103 ALESTA / CHROM - CHROME - KROM



Kopfbrause/ Overhead Shower/ Tepe Duşu: 200 mm
Länge / Length / Uzunluk: 150 mm
Verbindung/ Connection/Bağlantı: G 1/2"
Verstellbare Höhe/ Adjustable Height
/Ayarlanabili Yükseklik

BD44029104 CASSO / CHROM - CHROME - KROM



Kopfbrause/ Overhead Shower/ Tepe Duşu: 255x190 mm
Länge / Length / Uzunluk: 150 mm
Verbindung/ Connection/Bağlantı: G 1/2"
Verstellbare Höhe/ Adjustable Height
/Ayarlanabili Yükseklik

BD44029506 FLAT / SATIN-SCHWARZ/ SATIN BLACK/ SATEN SİYAH



Kopfbrause/ Overhead Shower/ Tepe Duşu: 222 mm
Länge / Length / Uzunluk: 150 mm
Verbindung/ Connection/Bağlantı: G 1/2"
Verstellbare Höhe/ Adjustable Height
/Ayarlanabili Yükseklik

BD44029505 FERRA / SATIN-SCHWARZ/ SATIN BLACK/ SATEN SİYAH



440536 AQUA / SCHWARZ -BLACK - SİYAH



191037 MINLINE EINGEBAUT/BUILT-IN/ANKASTRE / CHROM - CHROME - KROM

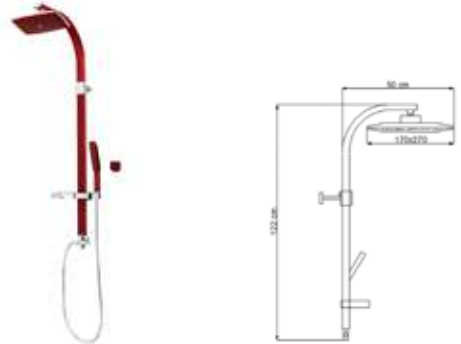

440534 MODERN / ROT - RED- KIRMIZI



900532 STEP / SATIN-SCHWARZ/ SATIN BLACK/ SATEN SİYAH

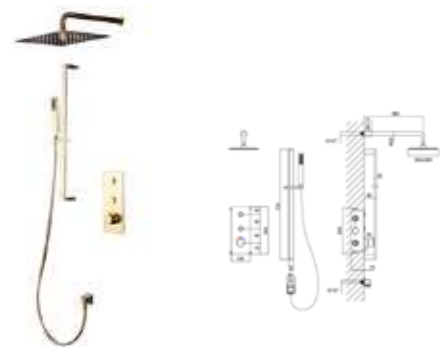

900116 STEP / GOLD



DUSCHKABINEN
SHOWER CABINS
DUŐAKABİNLER

DUSCHKABINEN / SHOWER CABINS / DUŞAKABİNLER



CODE	Messung/ Size/Ölçü:
ARA-042	120 cm
ARA-043	130 cm
ARA-044	140 cm
ARA-045	150 cm
ARA-046	160 cm
ARA-047	170 cm
ARA-048	180 cm
ARA-049	190 cm
ARA-050	200 cm

ARA PLUTON / H: 180 cm



CODE	Messung/ Size/Ölçü:
ARA-026	90 cm
ARA-027	100 cm
ARA-028	110 cm
ARA-029	120 cm
ARA-030	130 cm
ARA-031	140 cm
ARA-032	150 cm
ARA-033	160 cm

ARA SATURN / H: 180 cm



CODE	Messung/ Size/Ölçü:
ARA-021	70 cm
ARA-022	75 cm
ARA-023	80 cm
ARA-024	85 cm
ARA-025	90 cm
ARA-026	95 cm
ARA-027	100 cm
ARA-028	105 cm
ARA-029	110 cm
ARA-030	115 cm
ARA-031	120 cm

ARA VENUS / H: 180 cm



CODE	Messung/ Size/Ölçü:
ARA-042	120 cm
ARA-043	130 cm
ARA-044	140 cm
ARA-045	150 cm
ARA-046	160 cm
ARA-047	170 cm
ARA-048	180 cm
ARA-049	190 cm
ARA-050	200 cm

ARA NEPTUN / H: 180 cm



CODE	Messung/ Size/Ölçü:
BOY-183	130 cm
BOY-184	140 cm
BOY-185	150 cm
BOY-186	160 cm
BOY-187	170 cm
BOY-188	180 cm
BOY-189	190 cm
BOY-190	200 cm

ARA RELAX / H: 180 cm



BADEZIMMERMÖBEL
BATHROOM FURNITURE
BANYO MOBİLYALARI

BADEZIMMERMÖBEL / BATHROOM FURNITURE / BANYO MOBİLYALARI



LEYLAK / WEISS / WHITE / BEYAZ



ANGEL / WEISS / WHITE / BEYAZ

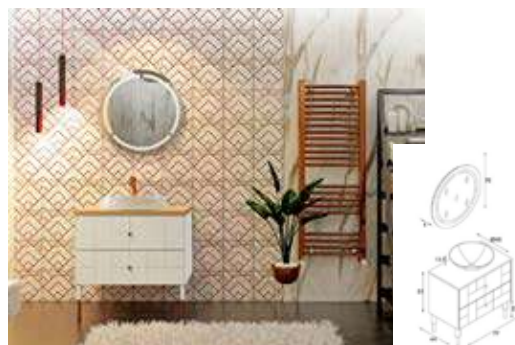

DUDEN / WEISS / WHITE / BEYAZ



ILGAZ / WEISS / WHITE / BEYAZ



DICLE / WEISS / WHITE / BEYAZ

BADEZIMMERMÖBEL / BATHROOM FURNITURE / BANYO MOBİLYALARI



KARLIOVA / WEISS / WHITE / BEYAZ

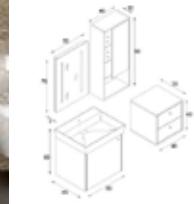

BAFA / WEISS / WHITE / BEYAZ



KARINA 100 / WEISS / WHITE / BEYAZ

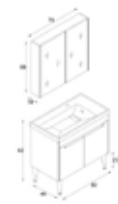

KARINA 80 / WEISS / WHITE / BEYAZ

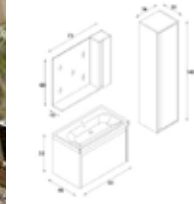

AKSU / WEISS / WHITE / BEYAZ

BADEZIMMERMÖBEL / BATHROOM FURNITURE / BANYO MOBİLYALARI



VENUS / WEISS / WHITE / BEYAZ



KAPADOKYA / WEISS / WHITE / BEYAZ



ARIN / ANTHRAZIT-NEU GRAU/ANTHRACITE-NEW GRAY/ ANTRASİT-YENİ GRİ



RIO 100 / WEISS / WHITE / BEYAZ



SAHRA / ANTHRAZIT-NEU GRAU/ANTHRACITE-NEW GRAY/ ANTRASİT-YENİ GRİ



BAD SIEBE
BATH STRAINERS
BANYO SÜZGEÇLERİ

BAD SIEBE / BATH STRAINERS / BANYO SÜZGEÇLERİ



LINE 1



LINE 2

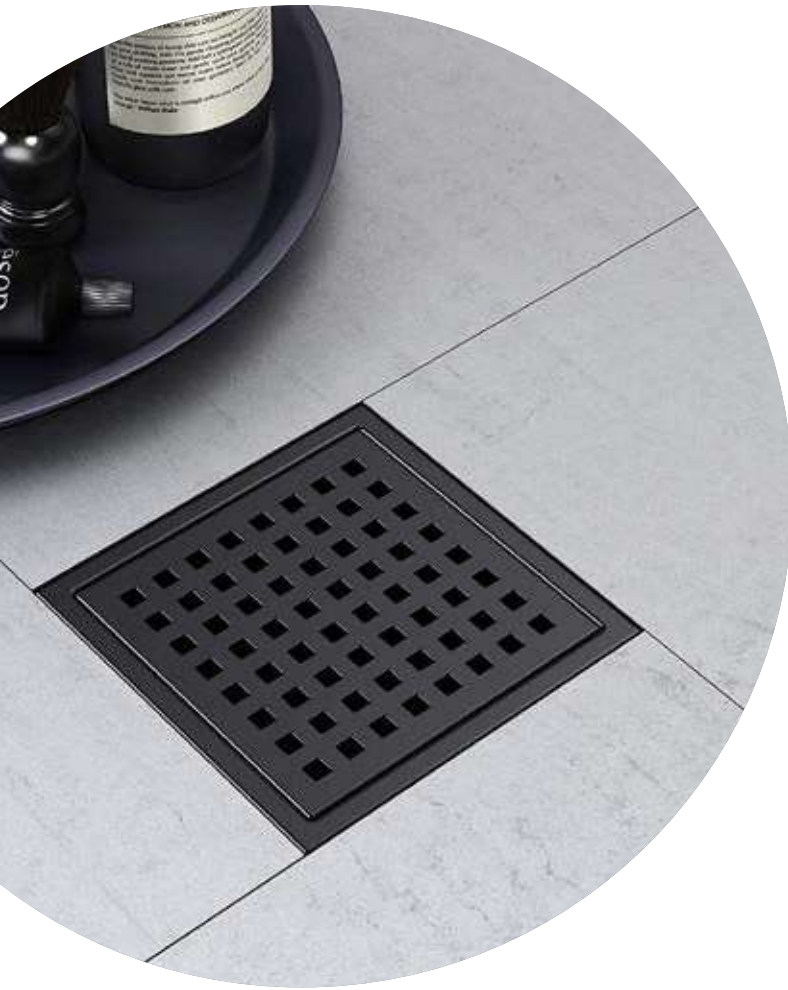

LINE 10



LINE 12



LINE 13



TOILETTEN
TOILETS
KLOZETLER

TOILETTEN / TOILETS / KLOZETLER



60 cm

KRKA060N1VP1W3000 KRISTAL NO-RIM / WEISS / WHITE / BEYAZ



56 cm

FRKA0566MVP1W3000 FRACTURE / WEISS / WHITE / BEYAZ



52 cm

FLKA052N1VP1W3000 FLASH NO-RIM / WEISS / WHITE / BEYAZ



62 cm

CPKD06201VS1W5SZO CAPRI / WEISS / WHITE / BEYAZ



60 cm

ORKD06001VS1W3SZO ORION / WEISS / WHITE / BEYAZ

TOILETTEN / TOILETS / KLOZETLER

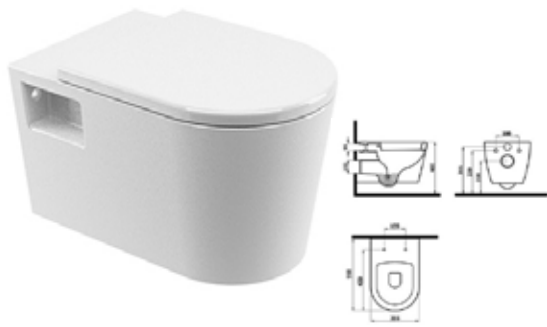

3825 IDEA / WEISS / WHITE / BEYAZ

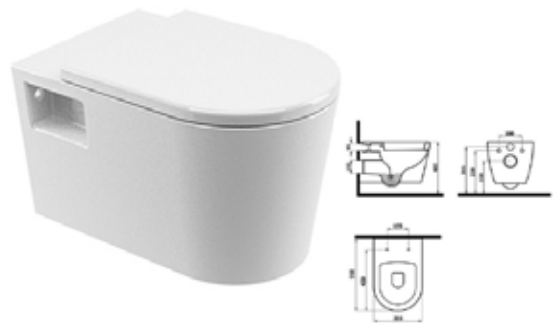

4823 POWER / WEISS / WHITE / BEYAZ

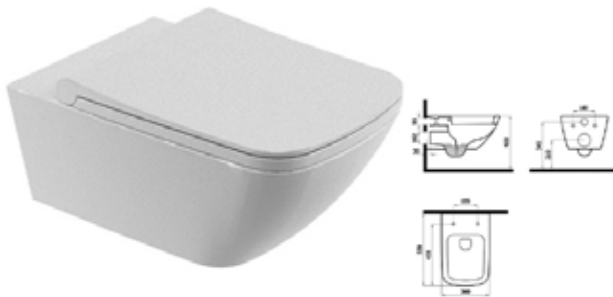

5823 LIFE / WEISS / WHITE / BEYAZ



5822 LOFT / WEISS / WHITE / BEYAZ



3822 MODERN / WEISS / WHITE / BEYAZ

TOILETTEN / TOILETS / KLOZETLER



54 cm

4948B403-6262 SENTO / WEISS / WHITE / BEYAZ



55 cm

7830B483-0090 PLURAL / MATT-SCHWARZ / MATTE BLACK / MAT SİYAH

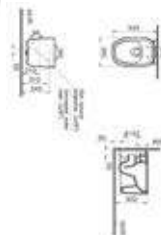

53 cm

4518B470-0090 ISTANBUL / WEISS / WHITE / BEYAZ

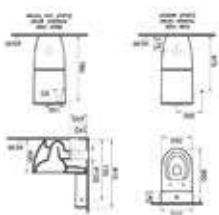

5987B003-0585 SENTO / WEISS / WHITE / BEYAZ



65 cm

4597B003-0088 SHIFT / WEISS / WHITE / BEYAZ



WASCHBECKEN
WASHBASINS
LAVABOLAR

WASCHBECKEN/ WASHBASINS / LAVABOLAR



40 cm

HRLG04001FD003000 HARMONY / GOLD-WEISS / GOLD-WHITE / ALTIN-BEYAZ
BODY TOP SPÜLE / BODY TOP SINK / GÖVDE ÜSTÜ LAVABO



45 cm

TPLA04501VD0W3000 TEK / WEISS / WHITE / BEYAZ
UNTERBAUSPÜLE / UNDERCOUNTER SINK / TEZGAH ALTI LAVABO



60 cm

LTLM06001FD0W3000 LOTUS MONOBLOK / WEISS / WHITE / BEYAZ



60 cm

NPLK06001FD1W3000 NEPTUN / WEISS / WHITE / BEYAZ
KONSOLE / CONSOLE / KONSOLLU



60 cm

TPLE06001VD1W3000 SPECIAL / WEISS / WHITE / BEYAZ
BEHINDERTES WASCHBECKEN / DISABLED SINK / ENGELLİ LAVABO

WASCHBECKEN/ WASHBASINS / LAVABOLAR



503080 EXEN / WEISS / WHITE / BEYAZ
 AUFTISCHES SPÜLE / OVER-COUNTER SINK / TEZGAH ÜSTÜ LAVABO



50156-W OVAL / GOLD-WEISS / GOLD-WHITE / ALTIN-BEYAZ
 AUFTISCHES SPÜLE / OVER-COUNTER SINK / TEZGAH ÜSTÜ LAVABO



506080 RIVER / WEISS / WHITE / BEYAZ



5800 LIFE / WEISS / WHITE / BEYAZ



3818 MONO / WEISS / WHITE / BEYAZ

WASCHBECKEN/ WASHBASINS / LAVABOLAR



5696B401-0041 FRAME / WEISS / WHITE / BEYAZ
AUFTISCHES SPÜLE / OVER-COUNTER SINK / TEZGAH ÜSTÜ LAVABO



5475B003-0642 S20 / WEISS / WHITE / BEYAZ
UNTERBAUSPÜLE / UNDERCOUNTER SINK / TEZGAH ALTI LAVABO



M58000010000 SYSTEM INFINIT / WEISS / WHITE / BEYAZ



50 cm

7814B477-0041 PLURAL / TERRA ROSA



45 cm

7811B475-0016 PLURAL HIGH / MATT MOOSGRÜN / MATT MOSS GREEN/
MAT YOSUN YEŞİLİ



DOORS
DOORS
KAPILAR



LK-01 / WEISS / WHITE / BEYAZ



LK-02 / WEISS / WHITE / BEYAZ



LK-03 / GRAU / GREY / GRİ



LK-04 / ANTHRAZIT / ANTHRACITE / ANTRASİT



LK-05 / CREME / CREAM / KREM

DOORS / DOORS / KAPILAR



LK-06 / CREME / CREAM / KREM



LK-07 / BRAUN / BROWN / KAHVERENGI



LK-08 / WEISS / WHITE / BEYAZ



LK-09A / HÖLZERN-WEISS / WOODEN-WHITE / AHŞAP-BEYAZ



LK-10 / GLASIERT WEISS / GLAZED WHITE / CAMLI BEYAZ



LK-30 / WEISS / WHITE / BEYAZ



LK-31 / WEISS / WHITE / BEYAZ



LK-33 / WEISS / WHITE / BEYAZ



LKS-34 STEEL DOOR / BRAUN / BROWN / KAHVERENGI



LKS-35 STEEL DOOR / ANTHRAZIT-BRAUN / ANTHRACITE-BROWN / KAHVERENGI-ANTRASIT



KERAMIK
CERAMIC
SERAMİK



2623 ALANYA / 60 x 120 cm



2624 ALANYA / 60 x 120 cm



2618 TITAN / 60 x 120 cm



2573 STONE / 60 x 60 cm

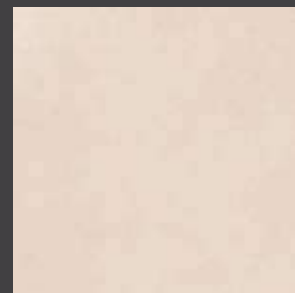

2574 STONE / 60 x 60 cm

KERAMIK / CERAMIC / SERAMİK



2531 METRO / 60 x 60 cm



2573 ONICE / 60 x 60 cm



2573 ONICE / 60 x 120 cm



2577 DOLAMITE / 60 x 60 cm



2578 FLORANCE / 60 x 60 cm



CANYON



CANYON Beige Beige
60x120cm | 24"x48"



CANYON Beige Beige
60x60cm | 24"x24"

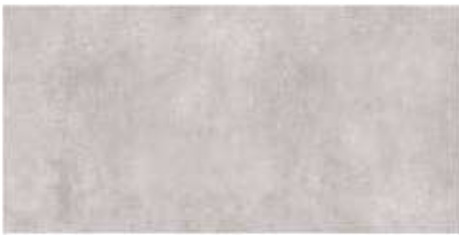

CANYON Gull Grey
60x120cm | 24"x48"



CANYON Gull Grey
60x60cm | 24"x24"



CANYON Black Stone
60x120cm | 24"x48"



CANYON Black Stone
60x60cm | 24"x24"

TERAZZO



TERAZZO CH 1 Grey
60x120cm | 24"x48"



TERAZZO CH 1 Grey
60x60cm | 24"x24"



TERAZZO Beige Beige
60x120cm | 24"x48"



TERAZZO Beige Beige
60x60cm | 24"x24"



TERAZZO Gull Grey 1 Gull Grey
60x120cm | 24"x48"



TERAZZO Gull Grey 1 Gull Grey
60x60cm | 24"x24"





SERAWOOD



SERAWOOD Baj | Beige
60x120cm | 24"x48"



SERAWOOD Baj | Beige
60x60cm | 24"x24"



SERAWOOD Kahve | Brown
60x120cm | 24"x48"



SERAWOOD Kahve | Brown
60x60cm | 24"x24"



SERAWOOD Gri | Grey
60x120cm | 24"x48"



SERAWOOD Gri | Grey
60x60cm | 24"x24"

NARELLA



NARELLA Akçe | Light Grey
60x120cm | 24"x48"



NARELLA Akçe | Light Grey
60x60cm | 24"x24"



NARELLA Gri | Grey
60x120cm | 24"x48"



NARELLA Gri | Grey
60x60cm | 24"x24"



NARELLA Beyaz | Beige
60x120cm | 24"x48"



NARELLA Beyaz | Beige
60x60cm | 24"x24"



GASBETON
GAS CONCRETE
GAZBETON

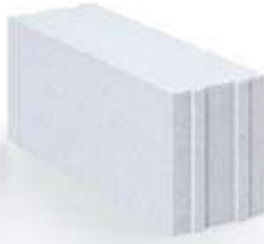

BLOK

GASBETON GAS CONCRETE GAZBETON

$\lambda_h = 0,11-0,19 \text{ W/mK}$

Produktionsgrad / Production Grade / Üretim Sınıfı	Schüttgewicht der Trockeneinheit / Dry Unit Bulk Weight / Kuru Birim Hacim Ağırlığı	Durchschnittliche Druckfestigkeit / Average Compressive Strength / Ortalama Basınç Dayanımı	Wärmeleitfähigkeitswert (Akonto) / Thermal conductivity value (Account) / Isli iletkenlik değeri (Ahesap)	Auslegungsgewicht* / Design Weight* / Tasarım Ağırlığı*	Versandgewicht** / Shipping Weight** / Nakliye Ağırlığı**	Reaktion auf Brandklasse / Reaction to Fire Class / Yangına Tepki Sınıfı	Feuerwiderstandszeit / Fire Resistance Time / Yangın Dayanım Süresi	Maße*** Dimensions*** Boyutlar***		Produktprofilstruktur / Product Profile Structure / Ürün Profil Yapısı	Produktionsstandard / Dokument / Production Standard / Document / Üretim Standardı / Belge
								L x h cm	d cm		
G2/04	400	2,5	0,11	490	560	A1	Ei 120 Ei 360	60 x 25	7,5-8,5-9-10- 12,5-13,5-15- 17,5-19-20-22,5- 25-27,5-30- 32,5-35-37,5-40	 	TS-EN 771-4 CE EPD UTO 2016/ 077
G4/06	600	5,0	0,19	730	840	A1			10-12,5-13,5- 15-17,5-19- 20- 22,5-25- 27,5- 30-32,5- 35- 37,5-40		

*Das Bemessungsgewicht ist das Gewicht der unverputzten Wand, die mit dem entsprechenden Block gebildet wird. * The design weight is the weight of the unplastered wall formed with the relevant block.

** Tasarım ağırlığı, ilgili blok ile oluşturulmuş sıvasız duvarın ağırlığıdır.

** Versandgewicht beinhaltet Palette, Verpackung etc. Gewichte sind nicht enthalten. ** Shipping weight includes pallet, packaging, etc. weights are not included. ** Nakliye ağırlığına palet, ambalaj vb. ağırlıklar dahil değildir.

*** Die Maßtoleranz beträgt ±1,5 mm Länge und Dicke, ±1,0 mm Höhe. *** Dimensional tolerance is ±1,5 mm in length and thickness, ±1,0 mm in height. *** Boyut toleransı uzunluk ve kalınlıkta ±1,5 mm, yükseklikte ±1,0 mm'dir.



0,09

$\lambda_h = 0,09 \text{ W/mK}$

Produktionsgrad / Production Grade / Üretim Sınıfı	Schüttgewicht der Trockeneinheit / Dry Unit Bulk Weight / Kuru Birim Hacim Ağırlığı	Durchschnittliche Druckfestigkeit / Average Compressive Strength / Ortalama Basınç Dayanımı	Wärmeleitfähigkeitswert (Akonto) / Thermal conductivity value (Account) / Isli iletkenlik değeri (Ahesap)	Auslegungsgewicht* / Design Weight* / Tasarım Ağırlığı*	Versandgewicht** / Shipping Weight** / Nakliye Ağırlığı**	Reaktion auf Brandklasse / Reaction to Fire Class / Yangına Tepki Sınıfı	Feuerwiderstandszeit / Fire Resistance Time / Yangın Dayanım Süresi	Maße*** Dimensions*** Boyutlar***		Produktprofilstruktur / Product Profile Structure / Ürün Profil Yapısı	Produktionsstandard / Dokument / Production Standard / Document / Üretim Standardı / Belge
								L x h cm	d cm		
G2/035	350	2,5	0,09	440	490	A1	Ei 120 Ei 360	60 x 25	10-12,5- 13,5- 15- 17,5-19- 20- 22,5-25-27,5- 30-32,5- 35- 37,5-40	 	TS EN 771-4 UTO 2016/071

*Das Bemessungsgewicht ist das Gewicht der unverputzten Wand, die mit dem entsprechenden Block gebildet wird. * The design weight is the weight of the unplastered wall formed with the relevant block.

** Tasarım ağırlığı, ilgili blok ile oluşturulmuş sıvasız duvarın ağırlığıdır.

** Versandgewicht beinhaltet Palette, Verpackung etc. Gewichte sind nicht enthalten. ** Shipping weight includes pallet, packaging, etc. weights are not included. ** Nakliye ağırlığına palet, ambalaj vb. ağırlıklar dahil değildir.

*** Die Maßtoleranz beträgt ±1,5 mm Länge und Dicke, ±1,0 mm Höhe. *** Dimensional tolerance is ±1,5 mm in length and thickness, ±1,0 mm in height. *** Boyut toleransı uzunluk ve kalınlıkta ±1,5 mm, yükseklikte ±1,0 mm'dir.

GASBETON / GAS CONCRETE / GAZBETON



HORIZONTALE WANDPLATTE / HORIZONTAL WALL PANEL /
YATAY DUVAR PANELİ



VERTIKALE WANDPLATTE / VERTICAL WALL PANEL /
DÜŞEY DUVAR PANELİ



VERTIKALE WANDELEMENTE / VERTICAL WALL ELEMENTS /
TAŞIYICI DÜŞEY DUVAR ELEMANLARI



TEILPLATTE / PARTITION PANEL /
BÖLME PANELİ



FEUERWAND / FIRE WALL /
YANGIN DUVARI



LÄRMSCHUTZ / NOISE BARRIER /
GÜRÜLTÜ BARIYERİ



LEICHTES GEHÄUSE MIT TASCHEN / LIGHT HOUSING WITH POCKETS / CEPLİ HAFİF ASMOLEN

Maße*** Dimensions*** Boyutlar***			Schüttgewicht der Trockeneinheit/ Dry Unit Bulk Weight/ Kuru Birim Hacim Ağırlığı	Statische Berechnungsgewichtung / Static Calculation Weight/ Statik Hesap Ağırlığı	Wärmeleitfähigkeitswert/ Thermal conductivity value/ Isıl iletkenlik değeri	Reaktion auf Brandklasse/ Reaction to Fire Class/ Yangına Tepki Sınıfı
Breite/ Width/En	Länge/ Height/Boy	Höhe/Height/ Yükseklik	kg/m ³	kg/m ³	W/mK	
40 oder or veya 50	50 oder or veya 60	20.0 - 22.5 25.0 - 27.5 30.0 - 32.5 35.0 - 37.5 40.0 - 42.5 45.0	290	410	0,09	A1





GIPS - GIPSKARTON
GYPSUM - GYPSUM BOARD
ALÇI-ALÇIPAN

GIPS - GIPSKARTON / GYPSUM - GYPSUM BOARD / ALÇI-ALÇIPAN

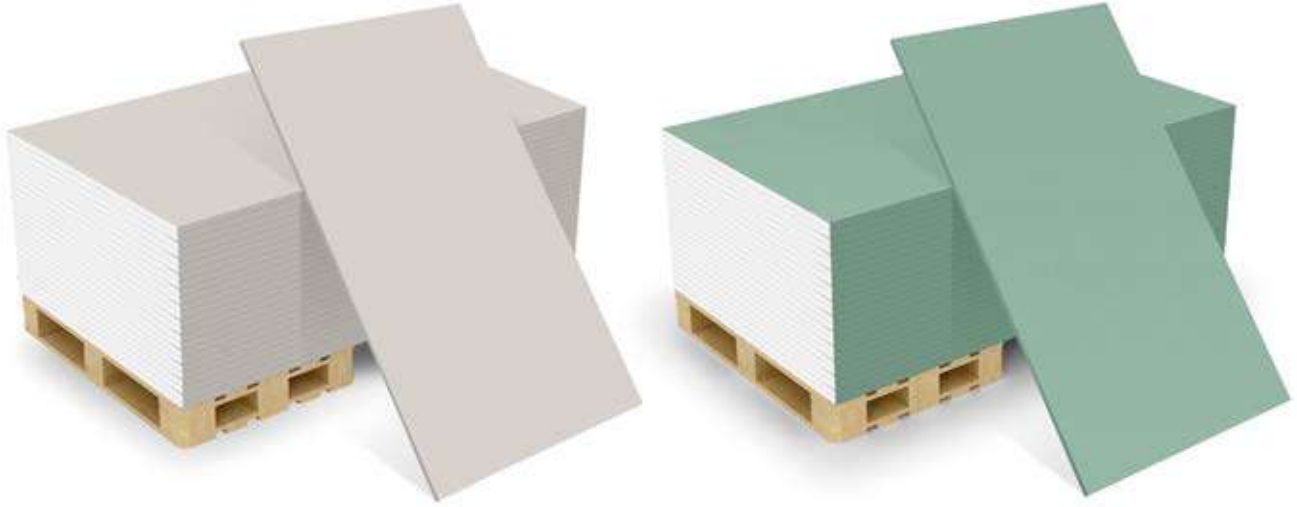

Dicke/Thickness/Kalınlık	Gewicht/Weight/Ağırlık	Länge/Length/Uzunluk	Breite/Width/Genişlik	Produktstandard/ Product Standard/ Ürün Standardı
8 mm	5 - 5.5 kg/m ²	2000-3600 mm	1200 mm	TS EN 520 + A1 - TİP A
9,5 mm	6 - 6.5 kg/m ²			
12,5 mm	7.5 - 8.0 kg/m ²			
15 mm	10 - 11 kg/m ²			

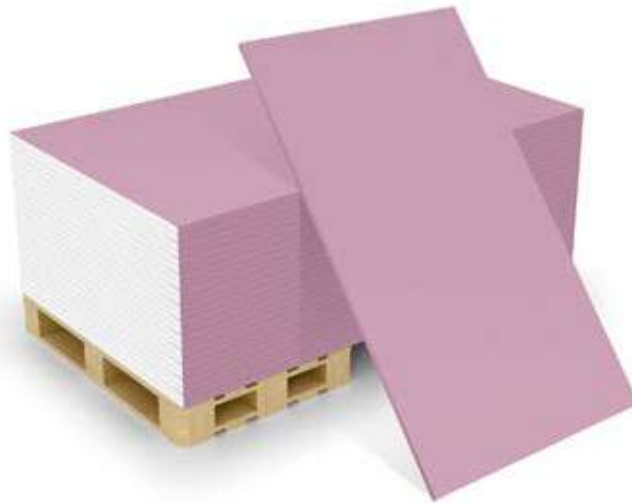

FEUERBESTÄNDIGE GIPSPLATTE / FIRE RESISTANT PLASTER PLATE / YANGINA DAYANIKLI ALÇI PLAKA

Dicke/Thickness/Kalınlık	Gewicht/Weight/Ağırlık	Länge/Length/Uzunluk	Breite/Width/Genişlik	Produktstandard/ Product Standard/ Ürün Standardı
12,5 mm	10 - 10.5 kg/m ²	2000-3600 mm	1200 mm	TS EN 520 + A1 - TİP FT
15 mm	10 - 11 kg/m ²			

GIPS - GIPSKARTON / GYPSUM - GYPSUM BOARD / ALÇI-ALÇIPAN



10077 Verzinkte Ecke / Galvanized Corner / Galvanizli Köşe

Größe / Size / Boy	270 mm
Gewicht / Weight / Ağırlık	0.40 kg



90077 Aluminiumecke / Aluminum Corner / Alüminyum Köşe

Größe / Size / Boy	270 mm
Gewicht / Weight / Ağırlık	0.35 kg

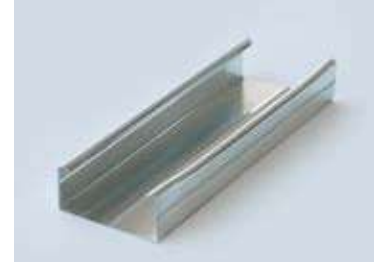

C50 Decke C-Profil / Ceiling U Profile / Tavan C Profili

Maße / Dimensions / Ebatlar	27x60x27 cm
Größe / Size / Boy	300 mm
Gewicht / Weight / Ağırlık	0.50 - 0.60 kg

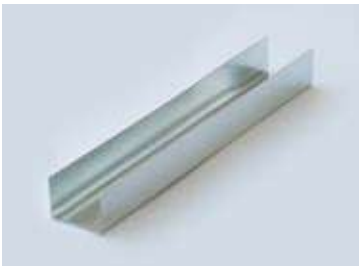

U28 Decke U-Profil / Ceiling U Profile / Tavan U Profili

Maße / Dimensions / Ebatlar	26x28,5x26 mm
Größe / Size / Boy	300 mm
Gewicht / Weight / Ağırlık	0.50 - 0.60 kg



C50 Wand-C-Profil / Wall C Profile / Duvar C Profili

Maße / Dimensions / Ebatlar	42x48,8x42 mm
Größe / Size / Boy	300 mm
Gewicht / Weight / Ağırlık	0.50 - 0.60 kg

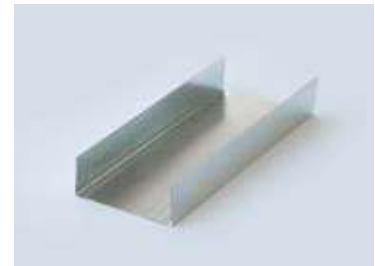

U50 Wand-U-Profil / Wall U Profile / Duvar U Profili

Maße / Dimensions / Ebatlar	27,5x50x27,5 mm
Größe / Size / Boy	300 mm
Gewicht / Weight / Ağırlık	0.50 - 0.60 kg



6034 Kleiderbügelzange / Hanger Tongs / Askı Maşası



6157 KLIPS

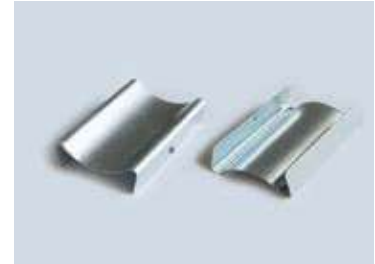

60902 Einfügung / Insert / Ekleme Parçası



6034 Doppelfederzange / Double Spring Tongs / Çift Yaylı Maşa



6157 AGRAF

Maße / Dimensions / Ebatlar	7,5-12-15-20-30-40 cm
------------------------------------	-----------------------



6042 Kleiderbügel mit Haken / Öse / Hanger Wire with Hook / Eye / Askı Teli Kancalı / Gözülü

Maße / Dimensions / Ebatlar	20-30-40-50-60-80-100-120-140-150-200-300 cm
------------------------------------	--

GIPS - GIPSKARTON / GYPSUM - GYPSUM BOARD / ALÇI-ALÇIPAN



SIVA 1982 25 Kg
GIPS/PLASTER/SIVA

Wasser mischen / Mixing Water /
Karışım Suyu

10 kg verputzen/to plaster/alçıya
6,0-6,5 lt wasser/water/su

Einfrierendes Ende / Freezing End /
Donma Sonu

150 minute/dakika +/- % 10

Trockenzeit / Drying Time /
Kuruma Süresi

max. 4 tag/day/gün

Biegefestigkeit / Flexural Strength /
Eğilme Mukavemeti

min. 1,0 N/mm²



SIVA 1982 35 Kg
GIPS/PLASTER/SIVA

Wasser mischen / Mixing Water /
Karışım Suyu

10 kg verputzen/to plaster/alçıya
6,0-6,5 lt wasser/water/su

Einfrierendes Ende / Freezing End /
Donma Sonu

150 minute/dakika +/- % 10

Trockenzeit / Drying Time /
Kuruma Süresi

max. 4 tag/day/gün

Biegefestigkeit / Flexural Strength /
Eğilme Mukavemeti

min. 1,0 N/mm²



SATEN 25 Kg
SATINPUTZ/SATIN PLASTER/
SATEN ALÇI

Wasser mischen / Mixing Water /
Karışım Suyu

10 kg verputzen/to plaster/alçıya
7 lt wasser/water/su

Einfrierendes Ende / Freezing End /
Donma Sonu

150 minute/dakika +/- % 10

Trockenzeit / Drying Time /
Kuruma Süresi

~ 2 tag/day/gün

Biegefestigkeit / Flexural Strength /
Eğilme Mukavemeti

min. 1,0 N/mm²

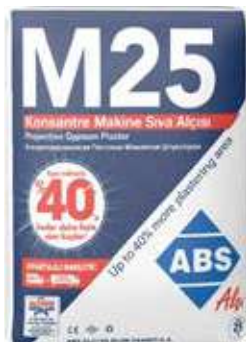

M25 25 Kg
KONZENTRIERTES MASCHINENPUTZPUTZ/
CONCENTRATED MACHINE PLASTER PLAS-
TER/KONSANTRE MAKİNE SIVA ALÇISI

Wasser mischen / Mixing Water /
Karışım Suyu

10 kg verputzen/to plaster/alçıya
7,0-7,2 lt wasser/water/su

Einfrierendes Ende / Freezing End /
Donma Sonu

220-240 minute/dakika +/- % 10

Druckfestigkeit / Compressive
Strength / Basınç Dayanımı

20 kgf/cm²(4x4x16 blok)

Biegefestigkeit / Flexural Strength /
Eğilme Mukavemeti

10 kgf / cm² (4x4x16 blok)



M95 35 Kg
MASCHINENPUTZ/MACHINE PLASTER/
MAKİNE SIVA ALÇISI

Wasser mischen / Mixing Water /
Karışım Suyu

10 kg verputzen/to plaster/alçıya
5,4-5,8 lt wasser/water/su

Einfrierendes Ende / Freezing End /
Donma Sonu

220-250 minute/dakika +/- % 10

Trockenzeit / Drying Time /
Kuruma Süresi

~ 4 tag/day/gün

Biegefestigkeit / Flexural Strength /
Eğilme Mukavemeti

min. 1,0 N/mm²







STEINWOLLE
STONEWOOL
TAŞ YÜNÜ



10cm

12cm

14cm

16cm

18cm

DÄMMLATTE / INSULATION BOARD / MANTOLAMA LEVHASI

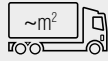
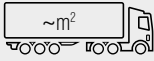
Produktcode/ Product code/ Ürün Kodu	Intensität/ Intensity/ Yoğunluk	Dicke/ Thickness/ Kalınlık	Maße/ Dimensions/ Ebat	Paket/ Package/ Paket			
	kg / m³	mm	mm x mm	Nummer/ Number/Adet	m²		
12050	120	50	600 × 1200	4	2.88	1.000	1.700
12060	120	60	600 × 1200	4	2.88	833	1.416
12070	120	70	600 × 1200	3	2.16	715	1.214
12080	120	80	600 × 1200	3	2.16	625	1.063
120100	120	100	600 × 1200	3	2.16	500	850
120120	120	120	600 × 1200	2	1.44	416	700
120150	120	150	600 × 1200	2	1.44	300	567
13050	130	50	600 × 1200	4	2.88	1.000	1.700
13060	130	60	600 × 1200	4	2.88	833	1.416
13070	130	70	600 × 1200	3	2.16	715	1.214
13080	130	80	600 × 1200	3	2.16	625	1.063
130100	130	100	600 × 1200	3	2.16	500	850
130120	130	120	600 × 1200	2	1.44	416	700
130150	130	150	600 × 1200	2	1.44	300	567
15020	150	20	600 × 1200	12	8.64	2.500	4.250
15025	150	25	600 × 1200	8	5.76	2.000	3.400
15030	150	30	600 × 1200	8	5.76	1.666	2.833
15040	150	40	600 × 1200	6	4.32	1.250	2.125
15050	150	50	600 × 1200	4	2.88	1.000	1.700
15060	150	60	600 × 1200	4	2.88	833	1.416
15070	150	70	600 × 1200	3	2.16	715	1.214
15080	150	80	600 × 1200	3	2.16	625	1.063
150100	150	100	600 × 1200	3	2.16	500	850
150120	150	120	600 × 1200	2	1.44	416	700

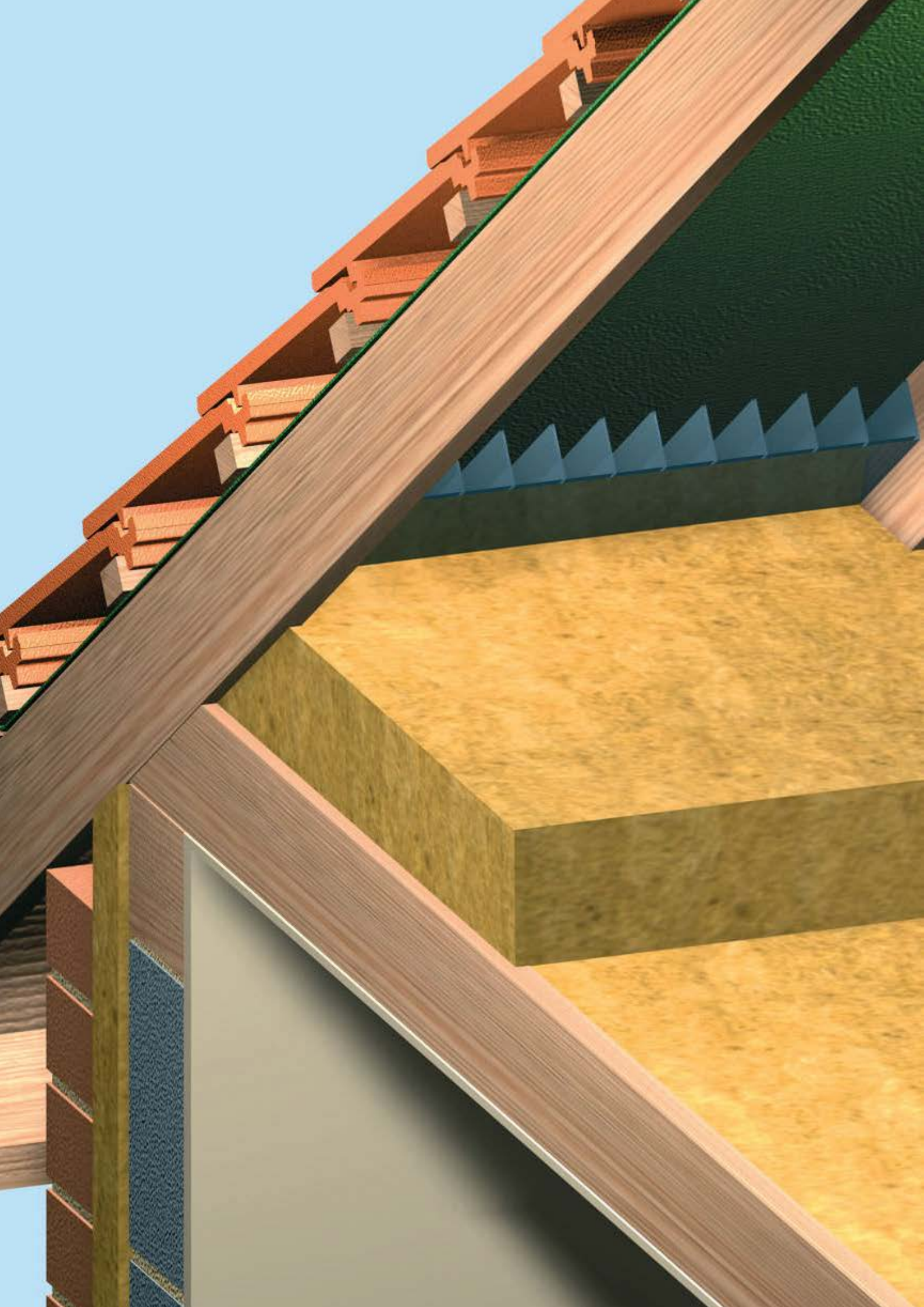



DACHMATRATZE / ROOF MATTRESS / ÇATI ŞİLTESİ



KLIMAAANLAGEPLATTE / AIR CONDITIONING PLATE / KLİMA LEVHASI



INDUSTRIEPLATTE / INDUSTRIAL PLATE / SANAYİ LEVHASI



INDUSTRIEMATRATZE / INDUSTRIAL MATTRESS / SANAYİ ŞİLTESİ



GLASWOLLE / GLASS WOOL / CAM YÜNÜ



MATRATZE AUS GLASWOLLE / GLASS WOOL MATTRESS / CAM YÜNÜ ŞİLTE



TEILPLATTE / PARTITION PLATE / ARA BÖLME LEVHASI



AUSSENBRETT / EXTERIOR BOARD / DIŐ CEPHE LEVHASI



SCHWIMMENDES BODENBOARD / FLOATING FLOOR BOARD /
YÜZER DÖŐEME LEVHASI



DÄMPLATTE / INSULATION BOARD / MANTOLAMA LEVHASI



TERRASSE DACHBOARD / TERRACE ROOF BOARD / TERAS ÇATI LEVHASI



BULK STEINWOLLE / BULK STONE WOOL / DÖKME TAŐ YÜNÜ



OFENPLATTE / OVEN PLATE / FIRIN LEVHASI



KLIMAAANLAGE AUS FOLIEN / FOIL AIR CONDITIONING BOARD / FOLYOLU KLİMA LEVHASI



PANELPLATTE/PANEL PLATE / PANEL LEVHASI



WÄRMEDÄMPLATTE FÜR INNENWAND / INTERNAL WALL THERMAL INSULATION BOARD / İÇTEN DUVAR ISI YALITIM LEVHASI



SCHIFFSPLATTE / SHIP PLATE / GEMİ LEVHASI



SCHIFF MATRATZE / SHIP MATTRESS / GEMİ ŞİLTESİ



EKSTRUDE POLISTIREN
EKSTRUDE POLISTIREN
XPS



Der angegebene Wert der Wärmeleitfähigkeit (bei 10 °C) beträgt $0,030 \leq \lambda \leq 0,035$ W/mK./

The thermal conductivity declared value (at 10 °C) is $0.030 \leq \lambda \leq 0.035$ W/mK. /

Isı iletkenlik beyan değeri (10 °C'de) $0,030 \leq \lambda \leq 0,035$ W/mK'dir.

Es kann als Platte in unterschiedlichen Größen und Druckstärken, mit unterschiedlichen Kanten- und Oberflächenformen, je nach Einsatzort und Verwendungszweck, hergestellt werden. /

It can be produced as a sheet in different sizes and compression strength, with different edge and surface shapes, depending on the place and purpose of use. /
Kullanım yeri ve amacına göre farklı boyut ve basma mukavemetinde, değişik kenar ve yüzey şekillerinde levha olarak üretilmektedir.

Je nach Wärmeleitfähigkeitswert liegt sie in den Wärmeleitfähigkeitsgruppen 030 und 035./

Depending on the thermal conductivity value, it is in the 030 and 035 thermal conductivity groups./

Isı iletkenlik değerine bağlı olarak 030 ve 035 ısı iletkenlik grubundadır.

Der Wasserdampfdiffusionswiderstandsfaktor beträgt $\mu = 90-100$ /

The water vapor diffusion resistance factor is $\mu = 90-100$ /

Su buharı difüzyon direnç faktörü $\mu = 90-100$ 'dür

Die Einsatztemperatur liegt zwischen -50/+75 °C./ The usage temperature is between -50/+75 °C./ Kullanım sıcaklığı -50/+75 °C aralığındadır.

Es hat eine homogene Zellstruktur mit 100 % geschlossenen Poren und nimmt kein Wasser auf./

It has a homogeneous cell structure with 100% closed pores and does not absorb water./

%100 kapalı gözenekli homojen hücre yapısına sahip olup bünyesine su almamaktadır.

Es gibt keine kapillare Saugfähigkeit./ There is no capillary absorbency./ Kapiler emiciliği yoktur.

Die Druckfestigkeit ist sehr hoch./ Compression strength is very high./ Basma dayanımı çok yüksektir.

Obwohl es gegenüber Säuren und Basen beständig ist, ist es empfindlich gegenüber Rauchgasen, Gasen der Methangruppe, Benzingruppe, Ether, Ester und Chemikalien der Amingruppe./

Although it is resistant to acid and base chemicals, it is sensitive to flue gases, methane group gases, gasoline group, ether, ester and amine group chemicals./
Asit ve baz kimyasallara dirençli olmasına karşın, baca gazları, metan grubu gazları, benzin grubu, eter, ester ve amin grubu kimyasallara karşı hassastır.

Es ist empfindlich gegenüber den ultravioletten Strahlen (UV) der Sonne. Es sollte vor direkter Sonneneinstrahlung geschützt werden./

It is sensitive to the ultraviolet rays (UV) of the sun. It should be protected from direct sunlight.

Güneşin mor ötesi ışınlarına (UV) karşı hassastır. Doğrudan güneş ışınlarından korunmalıdır.

Es ist in der E-Klasse gemäß TS EN 13501-1./ It is in E class according to TS EN 13501-1./ TS EN 13501-1'e göre E sınıfındadır.



EKSPANDE POLISTIREN
EKSPANDE POLISTIREN
EPS



Der angegebene Wert der Wärmeleitfähigkeit beträgt $0,032 \leq \lambda \leq 0,040$ W/mK./

The thermal conductivity declared value is $0,032 \leq \lambda \leq 0,040$ W/mK. /

Isı iletkenlik beyan değeri $0,032 \leq \lambda \leq 0,040$ W/mK'dir.

Es kann als Platte in unterschiedlichen Größen und Druckstärken, mit unterschiedlichen Kanten- und Oberflächenformen, je nach Einsatzort und Verwendungszweck, hergestellt werden. /

It can be produced as a sheet in different sizes and compression strength, with different edge and surface shapes, depending on the place and purpose of use. /
Kullanım yeri ve amacına göre farklı boyut ve basma mukavemetinde, değişik kenar ve yüzey şekillerinde levha olarak üretilmektedir.

Der Wasserdampfdiffusionswiderstandsfaktor beträgt $\mu = 20-100$ /

The water vapor diffusion resistance factor is $\mu = 20-100$ /

Su buharı difüzyon direnç faktörü $\mu = 20-100$ 'dür

Die Einsatztemperatur liegt zwischen $-50/+75$ °C./ The usage temperature is between $-50/+75$ °C. / Kullanım sıcaklığı $-50/+75$ °C aralığındadır.

Es gibt keine kapillare Saugfähigkeit./ There is no capillary absorbency. / Kapiler emiciliği yoktur.

Die Druckfestigkeit ist sehr hoch./ Compression strength is very high. / Basma dayanımı çok yüksektir.

Obwohl es gegenüber Säuren und Basen beständig ist, ist es empfindlich gegenüber Rauchgasen, Gasen der Methangruppe, Benzingruppe, Ether, Ester und Chemikalien der Amingruppe./

Although it is resistant to acid and base chemicals, it is sensitive to flue gases, methane group gases, gasoline group, ether, ester and amine group chemicals. /
Asit ve baz kimyasallara dirençli olmasına karşın, baca gazları, metan grubu gazları, benzin grubu, eter, ester ve amin grubu kimyasallara karşı hassastır.

Es ist empfindlich gegenüber den ultravioletten Strahlen (UV) der Sonne./

It is sensitive to the ultraviolet rays (UV) of the sun.

Güneşin mor ötesi ışınlarına (UV) karşı hassastır.

Es ist in der E-Klasse gemäß TS EN 13501-1./ It is in E class according to TS EN 13501-1. / TS EN 13501-1'e göre E sınıfındadır.



EPS OPTIMIER WAND-WÄRMEDÄMMPLATTE / WALL THERMAL INSULATION BOARD /
DUVAR ARASI ISI YALITIM LEVHASI

Produkttyp /Product Type/Ürün Tipi	EPS 30
Farbe /Color/Renk	Grau / Gray / Gri
Dicke /Thickness/Kalınlık	2cm - 20cm
Größe /Size/Ebat	50x100cm
Kantenform /Edge Shape/Kenar Şekli	Gerade /Straight/Düz
Zellinhalt /Cell content/Hücre içeriği	98% Luft /Air/Hava, 2% Polystyrol / Polystyrene/ Polistren
Verpackung /Packing/Ambalaj	PE-Nylon / PE naylon



EPS FASSADE WÄRMEDÄMMPLATTE/ THERMAL INSULATION BOARD /
ISI YALITIM LEVHASI

Produkttyp /Product Type/Ürün Tipi	EPS 50
Farbe /Color/Renk	Grau / Gray / Gri
Dicke /Thickness/Kalınlık	2cm - 20cm
Größe /Size/Ebat	50x100cm
Kantenform /Edge Shape/Kenar Şekli	Gerade /Straight/Düz
Zellinhalt /Cell content/Hücre içeriği	98% Luft /Air/Hava, 2% Polystyrol / Polystyrene/ Polistren
Verpackung /Packing/Ambalaj	PE-Nylon / PE naylon



EPS PLUS WÄRMEDÄMPLATTE / THERMAL INSULATION BOARD /
ISI YALITIM LEVHASI

Produkttyp/Product Type/Ürün Tipi	EPS 60- EPS 70-EPS 90 Graphitdotiert /Graphite Doped/ Grafit Katkılı
Farbe/Color/Renk	Grau / Gray / Gri
Dicke/Thickness/Kalınlık	2cm - 20cm
Größe/Size/Ebat	50x100cm
Kantenform/Edge Shape/Kenar Şekli	Gerade /Straight/Düz
Zellinhalt/Cell content/Hücre içeriği	98% Luft /Air/Hava, 2% Polystyrol / Polystyrene/ Polistren
Verpackung/Packing/Ambalaj	PE-Nylon / PE naylon

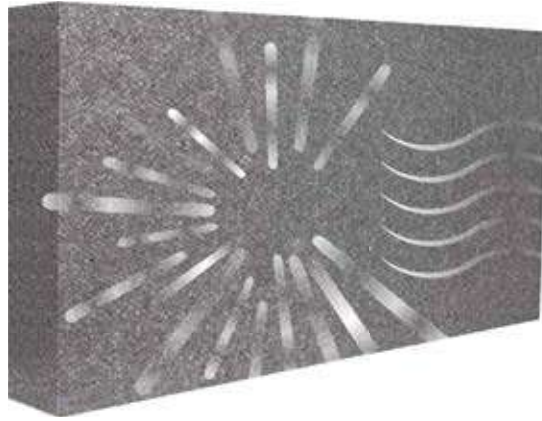

EPS PREMIUM WÄRMEDÄMPLATTE / THERMAL INSULATION BOARD /
ISI YALITIM LEVHASI

Produkttyp/Product Type/Ürün Tipi	EPS 70 Intensiv mit Graphit dotiert /Intense Graphite Doped/Yoğun Grafit Katkılı
Farbe/Color/Renk	Grau / Gray / Gri
Dicke/Thickness/Kalınlık	2cm - 20cm
Größe/Size/Ebat	50x100cm
Kantenform/Edge Shape/Kenar Şekli	Gerade /Straight/Düz
Zellinhalt/Cell content/Hücre içeriği	98% Luft /Air/Hava, 2% Polystyrol / Polystyrene/ Polistren
Verpackung/Packing/Ambalaj	PE-Nylon / PE naylon



MDF / MDF / MDF



**MDF-MATERIAL MIT MELAMIN
MELAMINE FACED MDF
MDF-LAM**



PANEL / PANEL / PANEL

MDF-MATERIAL MIT MELAMIN / MELAMINE FACED MDF / MDF-LAM



Ideale Holzlösungen für ideale Orte: MDF ist aufgrund seiner einwandfreien Oberflächenstruktur, seiner perfekten Verarbeitbarkeit und seiner ausgewogenen Faserverteilung ein perfektes Produkt... Lösungen, die Sie damit entwickeln, werden die Wahrnehmung von Qualität in Ihren Designs verändern.

Ideal wood solutions for ideal places: MDF is perfect product due to its impeccable surface structure, its perfect fabricability and its balanced dispersion of fibre... Solutions you develop with it, will change the perception of quality in your designs.

İdeal mekanların, İdeal ahşap çözümü: MDF, kusursuz yüzey yapısı, mükemmel işleme özelliği ve dengeli lif dağılımı ile harika bir ürün... Onunla geliştirdiğiniz çözümler, tasarımlarınızda kalite algısını değiştiriyor.

MDF / MDF / MDF

Optimale Dichte / Optimum density/ Optimum yoğunluk
Exzellente Oberflächenstruktur mit überragender Qualität / Excellent surface structure with superior quality / Üstün kaliteye sahip kusursuz yüzey yapısı
Hervorragende Verarbeitung / Excellent processing / Mükemmel işleme özelliği
Ausgewogene Faserverteilung / Balanced fiber distribution / Dengeli lif dağılımı
Hohe Biegefestigkeit / High resistance to bending / Eğilmeye karşı yüksek direnç
Hohe Quellbeständigkeit / High swelling resistance / Yüksek şişme direnci
Starker Körper / Strong body / Güçlü gövde
Materialstruktur geeignet für die Lackherstellung / Material structure suitable for painting manufacturing / Boyalı imalata uygun malzeme yapısı
Hohe Bolzengreif- und Ziehhaltbarkeit / High bolt gripping and drawing durability / Yüksek vida tutma ve çekme mukavemeti
Messungen / Measurements / Ölçüler: 2100 x 2800 mm - 2440 x 2800 mm - 1220 x 2800 mm - 1830 x 3660 mm

MDF-MATERIAL MIT MELAMIN / MELAMINE FACED MDF / MDF-LAM



L027
Alara / Alara

L002
Bianco

L005
Rot/Red/Kırmızı

Kratzfeste Acrylplatte / Anti-Scratch Acrylic Panel / Çizilmez Akrilik Panel

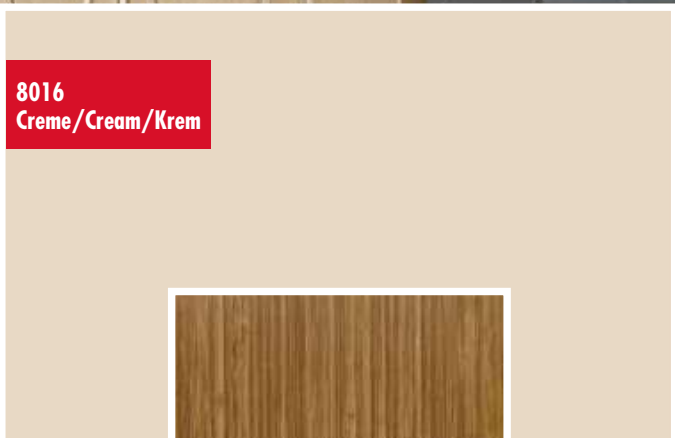
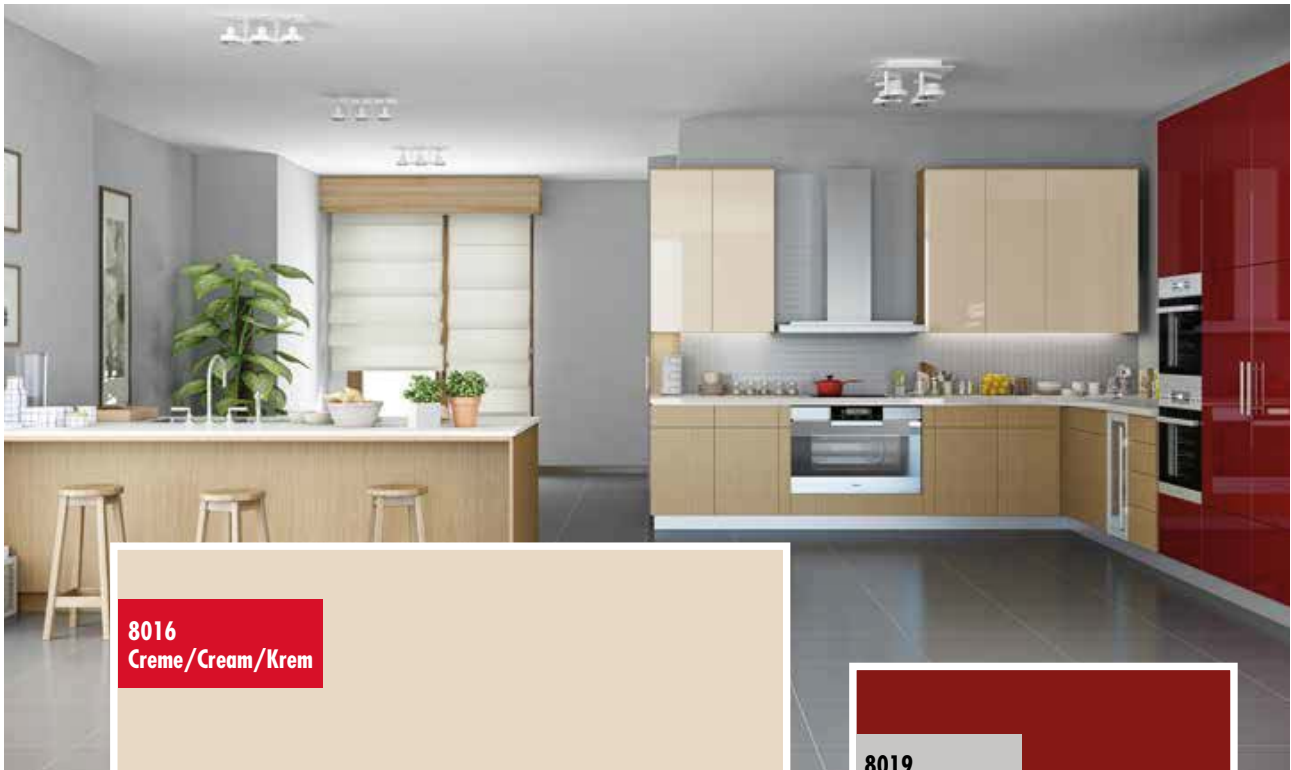

8016
Creme/Cream/Krem

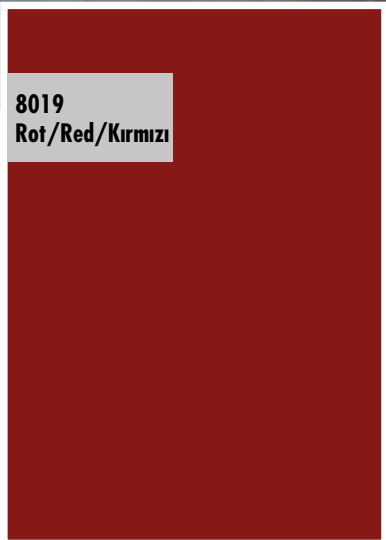

8019
Rot/Red/Kırmızı



367
Bamboo/Bambus/Bambu

Wandplatte / Wall Panel / Duvar Paneli



728
 Soft Touch Steingrau/
 Soft Touch Stone Grey/
 Soft Touch Kaya Gri

SU00173

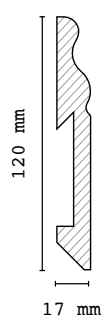

1010

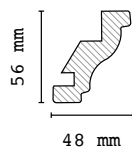

PR04122

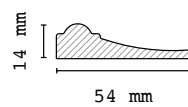

729
 Soft Touch Neu Grau/
 Soft Touch New Grey/
 Soft Touch Yeni Gri



INSTALLATIONSMATERIALIEN
INSTALLATION MATERIALS
TESİSAT MALZEMELERİ



CODE / KOD	
07.04.830	1/2"
07.04.831	3/4"
07.04.402	1"
07.04.403	1 1/4"
07.04.404	1 1/2"
07.04.405	2"

GASKUGELVENTIL VOLLER DURCHGANG/GAS BALL VALVE FULL BORE/
GAZ KÜRESEL VANASI TAM GEÇİŞLİ - (Mob 5)



CODE/ KOD	Löcher/ Holes/ Delik	CODE/ KOD	Löcher/ Holes/ Delik
18.21.782	2	18.21.788	8
18.21.783	3	18.21.789	9
18.21.784	4	18.21.790	10
18.21.785	5	18.21.791	11
18.21.786	6	18.21.792	12
18.21.787	7	18.21.793	13

VENTILSAMMLER - EDELSTAHL / VALVE COLLECTOR - STAINLESS STEEL /
VANALI KOLLEKTÖR - PASLANMAZ ÇELİK - 1"-16x2 (PN10)



CODE / KOD	
71.04.580	1/2"
71.04.581	3/4"
71.04.582	1"
71.04.583	1 1/4"
71.04.584	1 1/2"
71.04.585	2"

DRUCKMINDERER MIT MANOMETER/
PRESSURE REDUCER WITH MANOMETER/
MANOMETRELİ BASINÇ DÜŞÜRÜCÜ



CODE / KOD	EINSTELLEN / SET
94.37.440	8 Gerade/ Straight/ "li Düz
94.37.441	8 Ecke/Corner/"li Köşe
94.37.442	10 Gerade/ Straight/ "li Düz
94.37.443	10 Ecke/Corner/"li Köşe

KOMBI-ANSCHLUSSSET / COMBI CONNECTION SET / KOMBİ BAĞLANTI SETİ



Produkte für die Wasser- und Erdgasinstallation
Water and Natural Gas Installation Products
Su ve Doğalgaz Tesisat Ürünleri



CODE / KOD	U
54.01.050	50 cm
54.01.075	75 cm
54.01.100	100 cm
54.01.125	125 cm
54.01.150	150 cm
54.01.175	175 cm
54.01.200	200 cm

GEFLOCHTENER ERDGAS-ANSCHLUSS FLEXI-MUTTER-NIPPEL/
BRAIDED NATURAL GAS CONNECTION FLEXI NUT NIPPLE/
ÖRGÜLÜ DOĞALGAZ BAĞLANTI FLEXİ SOMUN NİPEL 1/2"-1/2"



Kollektor- und Fußbodenheizungsgruppe
Collector and Underfloor Heating Group
Kollektör ve Yerden Isıtma Grubu



Flex-Gruppe
Flex Group
Flex Grubu



Kastak-Gruppe
Kastak Group
Kastak Grubu



PPRC-Gruppe
PPRC Group
PPRC Grubu



92.11.305 BIDETTÜSE/BIDET NOZZLE/
TAHARET MUSLUĞU



92.11.302 BIDETTÜSE/BIDET NOZZLE/
TAHARET MUSLUĞU



92.11.345 BIDETTÜSE/BIDET NOZZLE/
TAHARET MUSLUĞU



92.11.343 BIDETTÜSE/BIDET NOZZLE/
TAHARET MUSLUĞU





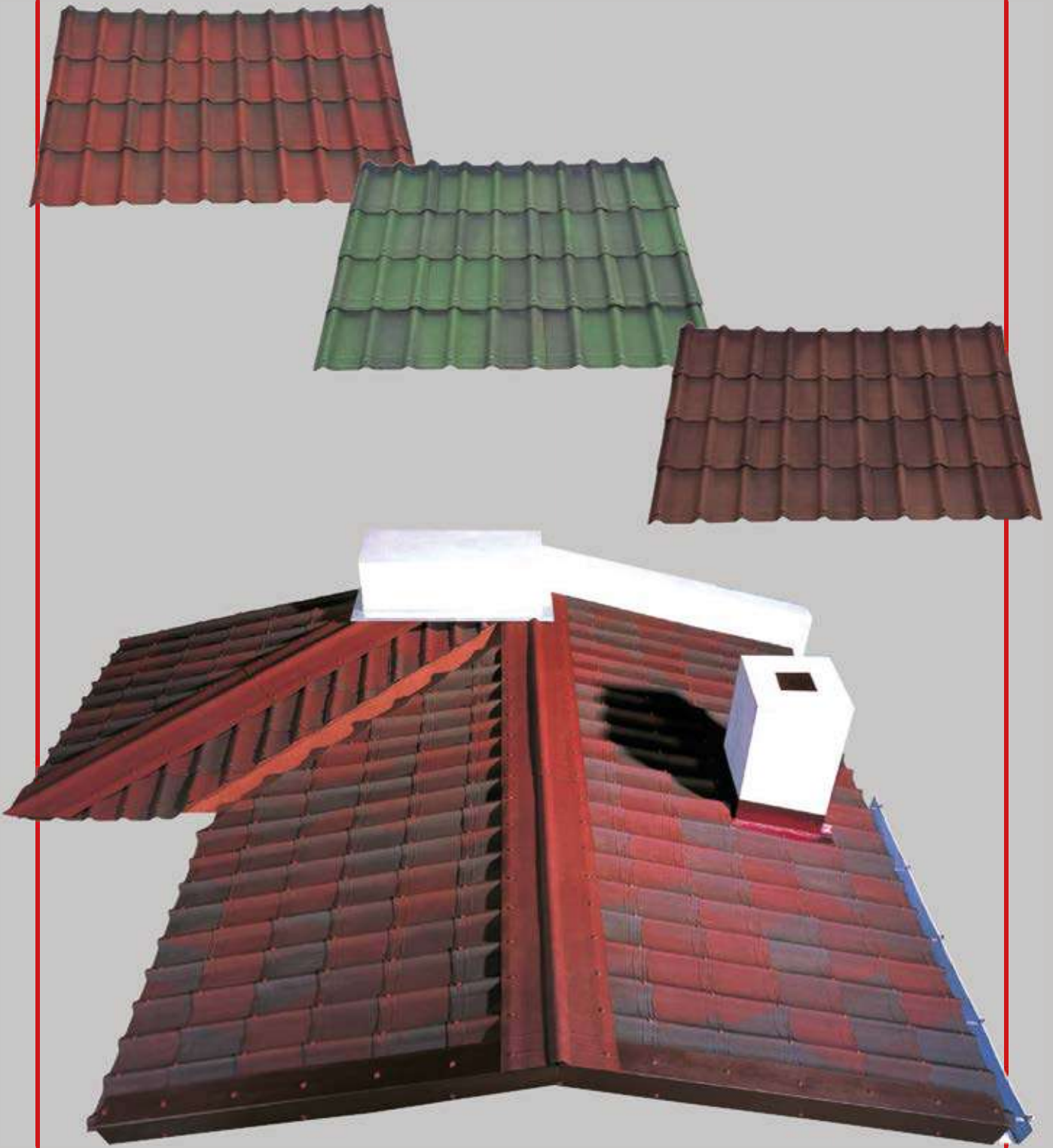

DACHUNG
ROOFING
ÇATI KAPLAMA



FARBE/COLOUR/ RENK	ROT/RED/KIRMIZI
CODE/KOD	03180251002
MASSE/ DIMENSIONS/ BOYUTLAR	107 x 40 cm



FARBE/COLOUR/ RENK	GRÜN/GREEN/ YEŞİL
CODE/KOD	03180251003
MASSE/ DIMENSIONS/ BOYUTLAR	107 x 40 cm



FARBE/COLOUR/ RENK	BRAUN/BROWN/ KAHVERENGİ
CODE/KOD	03180251004
MASSE/ DIMENSIONS/ BOYUTLAR	107 x 40 cm



FARBE/COLOUR/ RENK	TROJAN/TRUVA
CODE/KOD	03180244190
MASSE/ DIMENSIONS/ BOYUTLAR	107 x 40 cm

ZUBEHÖR AUS DEM GLEICHEN MATERIAL WIE DIE BOARDS/
ACCESSORIES MADE FROM THE SAME MATERIAL AS THE BOARDS/
LEVHALARLA AYNI MALZEMEDEN ÜRETİLEN AKSESUARLAR

	PRODUKT/PRODUCT/ÜRÜN	FARBE/COLOUR/RENK	CODE/KOD	MASSE/DIMENSIONS/BOYUTLAR
	DÜNNER Grat 106/ THIN ridge 106/ İNCE MAHYA 106	ROT/RED/KIRMIZI	05190244102	106 x 17,5 cm
		BRAUN/BROWN/KAHVERENGİ	05190244104	
		GRÜN/GREEN/YEŞİL	05190244103	
	STANDARD First/ STANDARD ridge/ STANDART MAHYA	ROT/RED/KIRMIZI	03310524102	200 x 48,5 cm
		BRAUN/BROWN/KAHVERENGİ	03310524103	
		GRÜN/GREEN/YEŞİL	03310524103	
	FLUSSENDE/ RIVER END/ MAHYA SONLAMA	ROT/RED/KIRMIZI	05190244202	106 x 17,5 cm
		BRAUN/BROWN/KAHVERENGİ	05190244204	
		GRÜN/GREEN/YEŞİL	05190244203	
	UNTERES WANDELEMENT/ WALL BOTTOM ELEMENT/ DUVAR DİBİ ELEMANI	ROT/RED/KIRMIZI	05190244302	102 x 14 cm
		BRAUN/BROWN/KAHVERENGİ	05190244304	
		GRÜN/GREEN/YEŞİL	05190244303	
	SEITLICHER VERSCHLUSS/ SIDE CLOSURE/ YAN KAPAMA	ROT/RED/KIRMIZI	05190244402	104 x 10,5 cm x H: 11,4 cm
		BRAUN/BROWN/KAHVERENGİ	05190244404	
		GRÜN/GREEN/YEŞİL	05190244403	



PVC-U ABWASSERROHRSYSTEME
PVC-U WASTE WATER PIPE SYSTEMS
PVC-U ATIK SU BORU SİSTEMLERİ



PVC-U-Rohr/Pipe/Boru
Typ B/Type B/B Tipi



PVC-U-Rohr/Pipe/Boru
Typ BD/Type BD/BD Tipi



PVC-U 87° Winkel/Elbow/Dirsek



PVC-U 45° Winkel/Elbow/Dirsek



PVC-U 45° Doppelgabel/Double Fork/
Çift Çatal



PVC-U 87° Doppelgabel/Double Fork/
Çift Çatal



PVC-U 45° Einzelgabel/Single Fork/
Tek Çatal



PVC-U 87° Einzelgabel/Single Fork/
Tek Çatal



PVC-U Die Ermäßigung/Reduction/
Redüksiyon



PVC-U-Gleithülse/Sliding Sleeve/
Kayar Manşon



PVC-S



PVC-U-Rückschlagventil/
Check Valve/Çek Valf



PVC-U-Reinigungsstück/
Cleaning Piece/Temizleme Parçası



87° Ellbogen reinigen/
Cleaning Elbow/Temizleme Dirsek



KADA



Stopper/Tapa



PVC-U-Luftkamin/Air Chimney/
Hava Bacası



PVC-U-Handschele/Handcuff/
Kelepçe



PVC-U-Adapterdichtung/
Adapter Gasket/Adaptör Conta



Dichtung/Gasket/Conta



FARBEN / PAINTS / BOYALAR

INNENFARBEN / INTERIOR PAINTS / İÇ CEPHE BOYLARI



IPEK MATT / MATTE / MAT



AMBIANS EXTRA MATT / MATTE / MAT



PERLA HALB MATT / HALF MATTE / YARI MAT



P1 MATT / MATTE / MAT



MATPLAST MATT / MATTE / MAT



**PRIMERA SILIKON MATT /
SILICONE MATTE / SİLİKONLU MAT**



**PERLA SILIKON MATT /
SILICONE MATTE / SİLİKONLU MAT**

DECKENFARBEN / CEILING PAINTS / TAVAN BOYLARI



ULTRA DECKE / CEILING / TAVAN



PERLA DECKE / CEILING / TAVAN



POPULER DECKE / CEILING / TAVAN



HOLZ-METALL-FARBEN / WOOD-METAL PAINTS / AHŞAP-METAL BOYALARI



MATRIX MATT / MATTE / MAT



PRIMERA GLÄNZEND / SHINY / PARLAK



**POLIMETAL GERADE / STRAIGHT /
DÜZ**



POLIMETAL HAMMER



KRK BAUSTOFFE

"Geheimnis der Meister"

AUSSENFARBEN / EXTERIOR PAINTS / DIŞ CEPHE BOYALARI



EXELANS TURBO FLEX C1



EXELANS TURBO



EXELANS GERADE/STRAIGHT/DÜZ



EXELANS DEKORATIVE KÖRNING/DECORATIVE GRAINY/
DEKORATIF GRENLI

DEKORATIVE FARBEN / DECORATIVE PAINTS / DEKORATİF BOYALAR



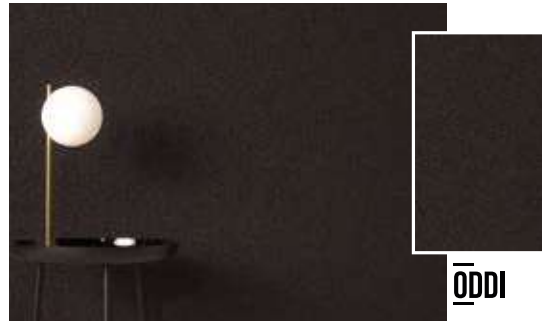

DEKORATIVE FARBEN / DECORATIVE PAINTS / DEKORATİF BOYALAR



BÖDEN / FLOORING / PARKELER

Breite/Width/En
193 mm
Länge/Height/Boy
1200 mm
Dicke/Thickness/Kalinlik
8 mm



PRK104 VEGAS / GRAU - GREY - GRİ

Breite/Width/En
193 mm
Länge/Height/Boy
1200 mm
Dicke/Thickness/Kalinlik
8 mm



PRK102 ANEMON / CREME - CREAM - KREM



Breite/Width/En
193 mm
Länge/Height/Boy
1200 mm
Dicke/Thickness/Kalinlik
8 mm



PRK108 DEFNE / BRAUN - BROWN - KAHVERENGİ

Breite/Width/En
191 mm
Länge/Height/Boy
1200 mm
Dicke/Thickness/Kalinlik
8 mm



PRK1109 PORTO / GRAU - GREY - GRİ

Breite/Width/En
191 mm
Länge/Height/Boy
1200 mm
Dicke/Thickness/Kalinlik
8 mm



PRK214 PATARA / GRAU - GREY - GRİ

BÖDEN / FLOORING / PARKELER



Breite/Width/En	191 mm
Länge/Height/Boy	1200 mm
Dicke/Thickness/Kalınlık	8 mm

PRK502 NIL / GRAU - GREY - GRİ



Breite/Width/En	188 mm
Länge/Height/Boy	1200 mm
Dicke/Thickness/Kalınlık	8 mm

PRK000 LIKYA / BRAUN - BROWN - KAHVERENĞİ



Breite/Width/En	154,5 mm
Länge/Height/Boy	1380 mm
Dicke/Thickness/Kalınlık	8 mm

PRK302 NAPOLI / GRAU - GREY - GRİ



Breite/Width/En	246 mm
Länge/Height/Boy	1380 mm
Dicke/Thickness/Kalınlık	8 mm

PRK303 MINORI / GRAU - GREY - GRİ



Breite/Width/En	154,5 mm
Länge/Height/Boy	1195 mm
Dicke/Thickness/Kalınlık	10 mm

PRK600 CASEELLA / GRAU - GREY - GRİ

Breite/Width/En
191 mm
Länge/Height/Boy
1200 mm
Dicke/Thickness/Kalinlik
8 mm



PRK903 EVEREST / GRAU - GREY - GRİ



Breite/Width/En
189 mm
Länge/Height/Boy
1195 mm
Dicke/Thickness/Kalinlik
12 mm

PRK907 URAL / BRAUN - BROWN - KAHVERENGI



Breite/Width/En
154,5 mm
Länge/Height/Boy
1195 mm
Dicke/Thickness/Kalinlik
12 mm

PRK904 ALP / GRAU - GREY - GRİ

Breite/Width/En
193 mm
Länge/Height/Boy
1380 mm
Dicke/Thickness/Kalinlik
10 mm



PRK708 CREAM / CREME - CREAM - KREM



Breite/Width/En
190 mm
Länge/Height/Boy
1200 mm
Dicke/Thickness/Kalinlik
12 mm

PRK704 GREY / GRAU - GREY - GRİ



**LVT (Luxus-Vinylfliese) BÖDEN /
LVT (Luxury Vinyl Tile) FLOORING /
LVT PARKELER**

LVT BÖDEN / LVT FLOORING / LVT PARKELER



STILO 1000



KLASIKA 1010



POEMO 1040



SENTEMA 1050



NEGO 1220

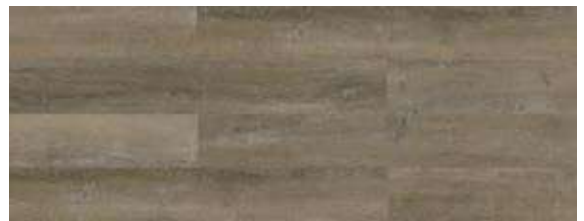

MORNA 1300



FEROCA G3000



GRACIA G3010



TITANO G3020



FORTA G4000



MASTRO G4010



RIGORA G4020



FENSTER / WINDOWS / PENCERELER



Profilbreite/Profile Width/Profil Geniřlięi	76 mm
Anzahl der Kammern/Number of Chambers/Odacık Sayısı	5
Klasse/Class/Sınıf	A Class - EN 12608-1
Dichtung/Gasket/Conta	TPE Grauschwarz Gray / Black - Gri / Siyah
Anzahl Dichtungen/Number of Gaskets/Conta Sayısı	3
Lamelle/Slat/Çıta	Einzelklaue-mit PCE-Dichtung/ Single claw - with PCE seal/ Tek tirnaklı - PCE contalı
Glasstärken/Glass Thicknesses/Cam Kalınlıkları	24, 30, 36, 44, 52 mm

DORADO 76



Profilbreite/Profile Width/Profil Geniřlięi	90 mm
Anzahl der Kammern/Number of Chambers/Odacık Sayısı	7
Klasse/Class/Sınıf	B Class - TS 5358 - EN 12608
Dichtung/Gasket/Conta	TPE Grauschwarz Gray / Black - Gri / Siyah
Anzahl Dichtungen/Number of Gaskets/Conta Sayısı	3
Lamelle/Slat/Çıta	Einzelklaue-mit PCE-Dichtung/ Single claw - with PCE seal/ Tek tirnaklı - PCE contalı
Glasstärken/Glass Thicknesses/Cam Kalınlıkları	24, 30, 36, 44, 52 mm

REVOTECH GOLD



Profilbreite/Profile Width/Profil Geniřlięi	84 mm
Anzahl der Kammern/Number of Chambers/Odacık Sayısı	7
Klasse/Class/Sınıf	B Class - TS 5358 - EN 12608
Dichtung/Gasket/Conta	TPE Grauschwarz Gray / Black - Gri / Siyah
Anzahl Dichtungen/Number of Gaskets/Conta Sayısı	3
Lamelle/Slat/Çıta	Einzelklaue-mit PCE-Dichtung/ Single claw - with PCE seal/ Tek tirnaklı - PCE contalı
Glasstärken/Glass Thicknesses/Cam Kalınlıkları	24, 30, 36, 44, 52 mm

REVOTECH



Profilbreite/Profile Width/Profil Geniřlięi	70 mm
Anzahl der Kammern/Number of Chambers/Odacık Sayısı	5
Klasse/Class/Sınıf	B Class - TS 5358 - EN 12608
Dichtung/Gasket/Conta	TPE Grauschwarz Gray / Black - Gri / Siyah
Anzahl Dichtungen/Number of Gaskets/Conta Sayısı	2
Lamelle/Slat/Çıta	Einzelklaue-mit PCE-Dichtung/ Single claw - with PCE seal/ Tek tirnaklı - PCE contalı
Glasstärken/Glass Thicknesses/Cam Kalınlıkları	4, 10, 20, 24, 26, 30, 36, 39 mm

SAFIR



TÜRGRIFFE
DOOR HANDLES
KAPI KOLLARI



ADRIA - HA128



AGATE - HA111



ALFA - HA147



APOLLO - HA127



AREL - HA139



ASTORIA - HA133



ATEN - HA137



ATLAS - HA170



AXE-T - HA186T



AXEL-T - HA187T



AZUR - HA104



BELINDA - HA155



BOLIVAR - HA123



BOLIVIANA - HA167



BUTTO - HA169



CARINA - HA159



ALUMINIUMTÜREN
ALUMINUM DOORS
ALÜMİNYUM KAPILAR



room
atta

PI kitchen





STECKDOSE UND SCHALTER
ELECTRICAL SOCKETS AND SWITCHES
ELEKTRİK PRİZİ VE ANAHTARLARI



BR010101 SCHALTER / SWITCH / ANAHTAR



BR010601 DOPPELSCHALTER MIT SCHALTER / LIGHTED DUAL SWITCH /
IŞIKLI İKİLİ ANAHTAR



2200402 GEERDETE STECKDOSE / GROUNDED SOCKET / TOPRAKLI PRİZ



2300701 GEERDETE BUCHSE MIT ABDECKUNG / GROUNDED SOCKET WITH
COVER / KAPAKLI TOPRAKLI PRİZ



OCTANS Aufputzdose / Surface-mounted socket /
Sıva üstü topraklı priz



OCTANS Aufputz-Schutzkontaktsteckdose mit Kinderschutz/
Surface mounted grounded socket with child protection /
Sıva üstü çocuk korumalı topraklı priz



N2301033 DOPPELKABEL MIT SCHALTER 2M./DOUBLE CORD WITH SWITCH 2M./ ANAHTARLI İKİLİ KORDONLU 2M.



N6301033 GESCHALTETE SECHSKABEL 2M. / SWITCHED SIX CORD 2M. / ANAHTARLI ALTILI KORDONLU 2M.



10028 QUADRATISCHES ZENTRUM / SQUARE CENTER/ KARE BUAT



10011 FERTIGE GEHÄUSEINSTALLATION / FINISHED CASE INSTALLATION / SIVA ALTI KASA GEÇMELİ



10002 MÄNNLICHER STECKER GEERDET / MALE PLUG GROUNDED / ERKEK FİŞ TOPRAKLI



10003 WEIBLICHER STECKER GEERDET / FEMALE PLUG GROUNDED / DIŞI FİŞ TOPRAKLI



152011008 **MONOPHASE** / MONOFAZE



152013007 **DREI PHASEN** / THREE-PHASE / TRIFAZ



60002 **1 POL, TYP B** / 1 POLE, B TYPE / 1 KUTUPLU, B TİPİ



27017026 **3P + N-POLIGE, TYP B** / 3P + N POLE, B TYPE / 3P + N KUTUPLU, B TİPİ



RITA 2 USB- UND GEERDETE STECKDOSE / 2 USB AND GROUNDED SOCKET / 2'Lİ USB VE TOPRAKLI PRİZ



3 GRUPPENSTECKDOSE MIT 3 USBS / 3 GROUP SOCKET WITH 3 USBS / 3 USB'Lİ 3'LÜ GRUP PRİZ



DESPINA TV-SAT



10002 36W HINTERGRUNDBELEUCHTUNG-PANEL-LEUCHE 3000K (60X60) / 36W BACKLIGHT PANEL LUMINAIRE 3000K (60X60) / 36W BACKLIGHT PANEL ARMATÜR 3000K (60X60)



BC03.0W-0127A 3W LED-BIRNE - 6500K / 3W LED BULB - 6500K / 3W LED AMPUL - 6500K



BM03.0W-0114A 3W Zündkerze TYP LED-BIRNE 6500K / 3W Spark Plug TYPE LED BULB 6500K / 3W BUJİ TİPİ LED AMPUL 6500K



DC06.0W-01005 6W SLIM LED-DOWNLIGHT - 6500K / 6W SLIM LED DOWNLIGHT - 6500K



DC03.0W-01005 3W SLIM LED-DOWNLIGHT - 6500K / 3W SLIM LED DOWNLIGHT - 6500K



1700MM - FREISTEHENDES GEHÄUSE / FREE STANDING PANEL /
DİKİLİ TİP PANO



AUFPUTZ-MONOBLOCK-SICHERUNGSVERTEILERPLATINE /
SURFACE MOUNTED MONOBLOCK FUSE DISTRIBUTION BOARD /
SIVA ÜSTÜ MONOBLOK SİĞORTALI DAĞITIM PANOSU



KUVARSPİRALKABELRINNEN-KOLLEKTOR / SPIRAL CABLE TRAY
COLLECTOR / SİRİAL KABLO KANALI TOPLAYICI



KABELBINDERKLEMME / CABLE TIE CLIP / KABLO BAĞI KLİPS



HÄKELARBEIT AUS KUNSTSTOFF MIT BETONNÄHTEN / PLASTIC CONCRETE
STUDED CROCHET / PLASTİK BETON ÇİVİLİ KROŞE



520119 NO:1 TERMINAL / KLEMENS

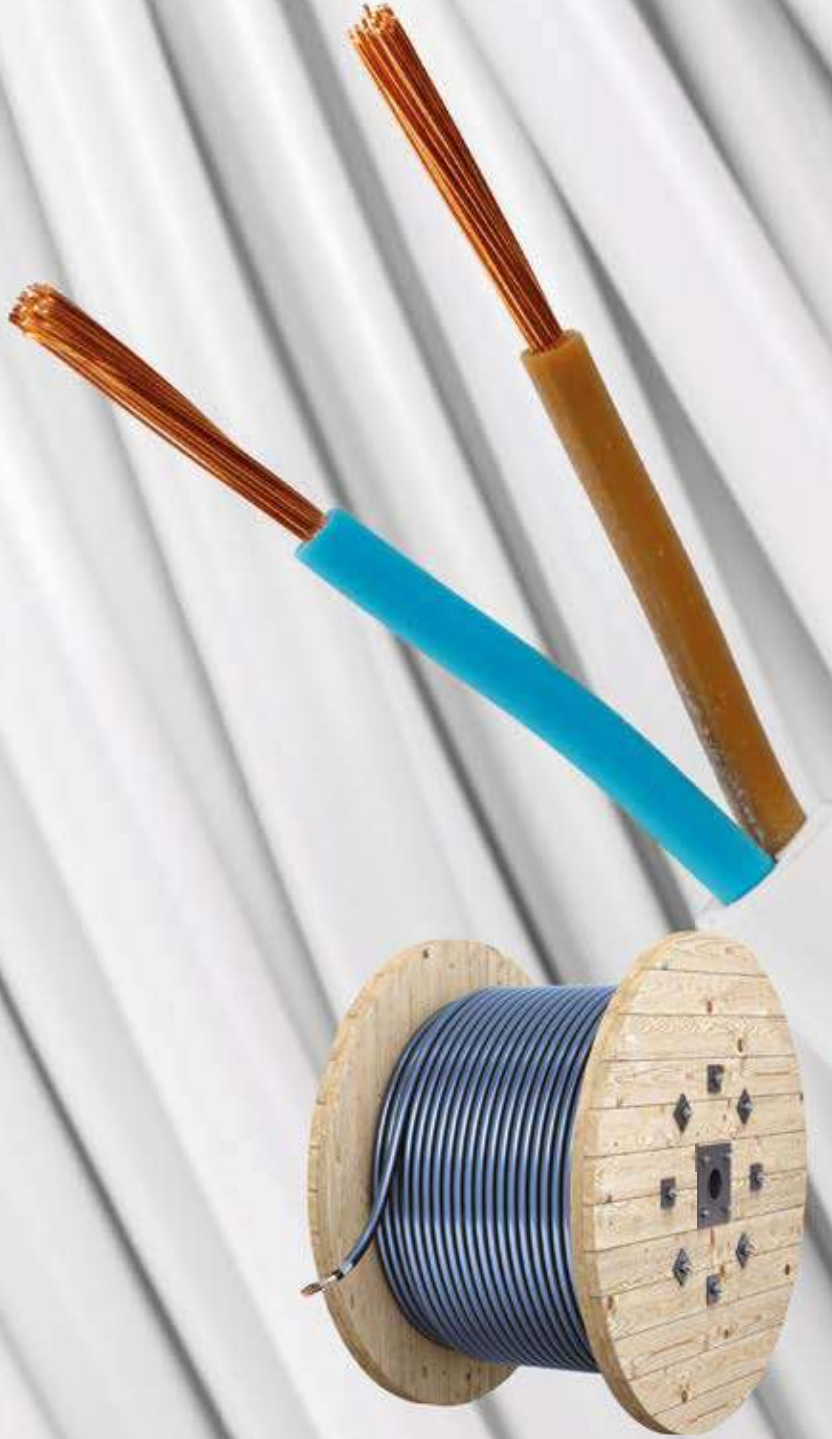

KABEL
CABLES
KABLOLAR



H03VH-H

zulässige Betriebstemperatur /permissible operating temperature/Müsaade edilen işletme sıcaklığı	70 °C
zulässige Kurzschlussstemperatur /permissible short-circuit temperature/ Müsaade edilen kısa devre sıcaklığı	
Nennspannung /Rated voltage/Beyan gerilimi	300/500V
Prüfspannung /Test voltage/Test gerilimi	



H03VVH2-F

zulässige Betriebstemperatur /permissible operating temperature/Müsaade edilen işletme sıcaklığı	70 °C
zulässige Kurzschlussstemperatur /permissible short-circuit temperature/ Müsaade edilen kısa devre sıcaklığı	
Nennspannung /Rated voltage/Beyan gerilimi	300/500V
Prüfspannung /Test voltage/Test gerilimi	



NVV

zulässige Betriebstemperatur /permissible operating temperature/Müsaade edilen işletme sıcaklığı	70 °C
zulässige Kurzschlussstemperatur /permissible short-circuit temperature/ Müsaade edilen kısa devre sıcaklığı	160 °C (Max. 5 min./sn.)
Nennspannung /Rated voltage/Beyan gerilimi	300/500V
Prüfspannung /Test voltage/Test gerilimi	2 kV - 2.5 kV (AC)



H03-05VV-F

zulässige Betriebstemperatur /permissible operating temperature/Müsaade edilen işletme sıcaklığı	70 °C
zulässige Kurzschlussstemperatur /permissible short-circuit temperature/ Müsaade edilen kısa devre sıcaklığı	
Nennspannung /Rated voltage/Beyan gerilimi	300/500V
Prüfspannung /Test voltage/Test gerilimi	



H05-07V-K

zulässige Betriebstemperatur /permissible operating temperature/Müsaade edilen işletme sıcaklığı	70 °C
zulässige Kurzschlussstemperatur /permissible short-circuit temperature/ Müsaade edilen kısa devre sıcaklığı	160 °C (Max. 5 min./sn.)
Nennspannung /Rated voltage/Beyan gerilimi	U ₀ /U - 300/500V
Prüfspannung /Test voltage/Test gerilimi	2 kV - 2.5 kV (AC)



H05-07V-U-R

zulässige Betriebstemperatur /permissible operating temperature/Müsaade edilen işletme sıcaklığı	70 °C
zulässige Kurzschlussstemperatur /permissible short-circuit temperature/ Müsaade edilen kısa devre sıcaklığı	160 °C (Max. 5 min./sn.)
Nennspannung /Rated voltage/Beyan gerilimi	U ₀ /U - 300/500V
Prüfspannung /Test voltage/Test gerilimi	2 kV - 2.5 kV (AC)



**STANDARD FASSADENPANEEL /
STANDARD FACADE PANEL /
STANDART CEPHE PANELİ**

STANDARD FASSADENPANEEL / STANDARD FACADE PANEL / STANDART CEPHE PANELİ

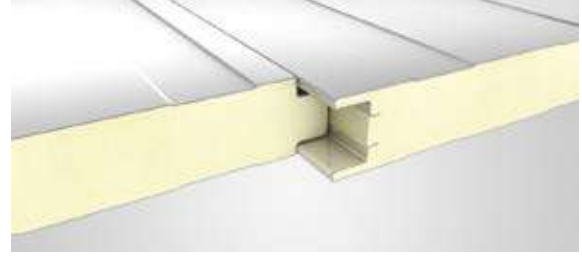

PUR/PIR isolierte Standard-Fassadenplatte / PUR/PIR Insulated Standard Facade Panel / PUR/PIR Yalıtımlı Standart Cephe Paneli

Produkt/ Product/ Ürün	Kerndicke/ Core Thickness/ Yalıtım Kalınlığı	Äußere Blechedicke/ Outer Sheet Thickness/ Dış Yüzey Kalınlığı**	Dicke des in- neren Blechs/ Inner Sheet Thickness/ İç Yüzey Kalınlığı**	Mindest. Länge/ Min. Length/ Min. Boy	max. Länge/ Max. Length/ Maks. Boy	Hitzeübertragungskoeffizient/ Heat Transfer Coefficient/ Isı Geçirgenlik Katsayısı*		Thermischer Widerstand/ Thermal Resistance/ Isıl Direnç**	
						U W/m ² K	R m ² K/W		
	d mm	t _{ne} mm	t _{ni} mm	m	m	Gefütert und Mikrogefütert/ Lined and Micro Lined / Çizgili ve Mikro Desenli	Tief gefütert/ Deep Lined/ Derin İzli	Gefütert und Mikrogefütert/ Lined and Micro Lined/Çizgili ve Mikro Desenli	Tief gefütert/ Deep Lined/ Derin İzli
WP-SP	40	0,40	0,35	2	12	0,57	0,57	1,75	1,75
WP-SM	50					0,45	0,45	2,22	2,22
WP-SD	60					0,37	0,37	2,71	2,71
WI-SP	70					0,31		3,18	
WI-SM	75					0,29		3,42	
WI-SD	80					0,27		3,66	
	100					0,22		4,58	
	120					0,18		5,49	
	150					0,15		6,84	
	180					0,12		8,21	
	200					0,11		9,12	

*Berechnet nach TS EN 14509 / Calculated according to TS EN 14509 / Hesaplamalar TS EN 14509'a uygun olarak yapılmıştır.

**Für weitere Dickenoptionen kontaktieren Sie uns bitte / For further thickness options please contact us / Kalınlık Seçenekleri için lütfen bize danışın.



**SILIKON/
SILICONES/
SİLİKONLAR**

100E
ALLGEMEINES SILIKON/
GENERAL PURPOSE SILICONE/
GENEL AMAÇLI SİLİKON



Chemischer Natur/Chemical nature/Kimyasal yapısı	Silikonpolymer/ Silicone Polymer/ Silikon Polimer	
Aushärtungstyp/Curing Type/Kürleşme Tipi	Acetoxy/Asetoksi	
Dichte/Density/Yoğunluk	0.96-0.98 g/ml	
Farbe/Color/Renk	In gewünschter Farbe/In Desired Color/ İstenilen renkte	
Shore A Härte/ Hardness/Sertlik	15-25 (28 Tag später/day later/gün sonra)	
Schalenbildung/Shell Formation/Kabuk Oluşumu	8-20 min/dk. (23°C - %50 B.N.)	
Aushärtengeschwindigkeit/Curing Speed/Kürleşme Hızı	Min. 2.5 mm/tag/day/gün (23°C - %50 B.N.)	
Zerreißeigenschaft/Tensile strength/Gerilme Direnci	≥ 0.7 N/mm ²	(ASTM D412)
Bruchdehnung/Elongation at Break/Kopma Uzaması	≥ 350 %	(ASTM D412)
Durchhängen/Sag/Sarkma	0 mm	(ISO 7390)
Anwendungstemperatur/Application Temperature/Üyulama Sıcaklığı	+5°C ile / +40°C	
Temperaturbeständigkeit/Temperature resistance/Sıcaklık dayanımı	-40°C / +180°C	

100S
KÜCHEN-BAD SILIKON/
KITCHEN-BATH SEALANT/
MUTFAK-BANYO SİLİKONU



Chemischer Natur/Chemical nature/Kimyasal yapısı	Silikonpolymer/ Silicone Polymer/ Silikon Polimer	
Aushärtungstyp/Curing Type/Kürleşme Tipi	Acetoxy/Asetoksi	
Dichte/Density/Yoğunluk	1.02±0.03 g/ml	
Shore A Härte/ Hardness/Sertlik	24-30 (28 Tag später/day later/gün sonra)	
Schalenbildung/Shell Formation/Kabuk Oluşumu	7-13 min/dk. (23°C - %50 B.N.)	
Aushärtengeschwindigkeit/Curing Speed/Kürleşme Hızı	Min. 3 mm/tag/day/gün (23°C - %50 B.N.)	
Zerreißeigenschaft/Tensile strength/Gerilme Direnci	≥ 0.4 N/mm ²	(ISO 8339)
Bruchdehnung/Elongation at Break/Kopma Uzaması	≥ 250 %	(ASTM D412)
Durchhängen/Sag/Sarkma	0 mm	(ISO 7390)
Elastische Rückkehr/Elastic Return/Elastik Geri Dönüş	~ %100	(ISO 7389)
Volumenverlust/Volume Loss/Hacim Kaybı	< % 5	(ISO 10563)
Anwendungstemperatur/Application Temperature/Üyulama Sıcaklığı	+5°C ile / +40°C	
Temperaturbeständigkeit/Temperature resistance/Sıcaklık dayanımı	-50°C / +200°C	

100D
DUSCHKABINE SILIKON/
SHOWER CABIN SILICONE/
DUŞKABİNİ SİLİKONU



Chemischer Natur/Chemical nature/Kimyasal yapısı	Silikonpolymer/ Silicone Polymer/ Silikon Polimer	
Aushärtungstyp/Curing Type/Kürleşme Tipi	Acetoxy/Asetoksi	
Dichte/Density/Yoğunluk	1.02±0.03 g/ml	
Shore A Härte/ Hardness/Sertlik	24-30 (28 Tag später/day later/gün sonra)	
Schalenbildung/Shell Formation/Kabuk Oluşumu	7-13 min/dk. (23°C - %50 B.N.)	
Aushärtengeschwindigkeit/Curing Speed/Kürleşme Hızı	Min. 3 mm/tag/day/gün (23°C - %50 B.N.)	
Zerreißeigenschaft/Tensile strength/Gerilme Direnci	≥ 0.4 N/mm ²	(ISO 8339)
Bruchdehnung/Elongation at Break/Kopma Uzaması	≥ 250 %	(ASTM D412)
Durchhängen/Sag/Sarkma	0 mm	(ISO 7390)
Elastische Rückkehr/Elastic Return/Elastik Geri Dönüş	~ %100	(ISO 7389)
Volumenverlust/Volume Loss/Hacim Kaybı	< % 5	(ISO 10563)
Anwendungstemperatur/Application Temperature/Üyulama Sıcaklığı	+5°C ile / +40°C	
Temperaturbeständigkeit/Temperature resistance/Sıcaklık dayanımı	-50°C / +200°C	

HT300
HOCHTEMPERATUR-SILIKON/
HIGH TEMPERATURE SILICONE/
YÜKSEK ISI SİLİKONU



Chemischer Natur/Chemical nature/Kimyasal yapısı	Silikonpolymer/ Silicone Polymer/ Silikon Polimer	
Aushärtungstyp/Curing Type/Kürleşme Tipi	Acetoxy/Asetoksi	
Dichte/Density/Yoğunluk	1.05±0.03 g/ml	
Shore A Härte/ Hardness/Sertlik	24-30 (28 Tag später/day later/gün sonra)	
Schalenbildung/Shell Formation/Kabuk Oluşumu	7-13 min/dk. (23°C - %50 B.N.)	
Aushärtengeschwindigkeit/Curing Speed/Kürleşme Hızı	Min. 3 mm/tag/day/gün (23°C - %50 B.N.)	
Zerreißeigenschaft/Tensile strength/Gerilme Direnci	≥ 1.5 N/mm ²	(ASTM D412)
Bruchdehnung/Elongation at Break/Kopma Uzaması	≥ 250 %	(ASTM D412)
Durchhängen/Sag/Sarkma	0 mm	(ISO 7390)
Elastische Rückkehr/Elastic Return/Elastik Geri Dönüş	≥ %60	(ISO 7389)
Anwendungstemperatur/Application Temperature/Üyulama Sıcaklığı	+5°C ile / +40°C	
Temperaturbeständigkeit/Temperature resistance/Sıcaklık dayanımı	-40°C / +300°C	

915N
NEUTRALES AUSSENSILIKON/
NEUTRAL EXTERIOR SILICONE/
NÖTR DIŞ CEPHE SİLİKONU



Chemischer Natur/Chemical nature/Kimyasal yapısı	Silikonpolymer/ Silicone Polymer/ Silikon Polimer	
Aushärtungstyp/Curing Type/Kürleşme Tipi	Neutral (Oxim)/Neutral (Oxime)/Nötr (Oksim)	
Dichte/Density/Yoğunluk	1.02±0.03 g/ml	
(Transparent und Aluminium/Transparent and Aluminum/ Şeffaf ve Alüminyum)		
Dichte/Density/Yoğunluk (Andere Farben/Other Colors/Diğer Renkler)	1.20±0.03 g/ml	
Shore A Härte/ Hardness/Sertlik	17-25 (28 Tag später/day later/gün sonra)	
(Transparent und Aluminium/Transparent and Aluminum/ Şeffaf ve Alüminyum)		
Shore A Härte/ Hardness/Sertlik (Andere Farben/Other Colors/Diğer Renkler)	22-32 (28 Tag später/day later/gün sonra)	
Zerreißeigenschaft/Tensile strength/Gerilme Direnci	≥ 0.4 N/mm ² (23°C - %50 B.N.)	(ISO 8339)
Schalenbildung/Shell Formation/Kabuk Oluşumu	5-10 min/dk. (23°C - %50 B.N.)	
Aushärtengeschwindigkeit/Curing Speed/Kürleşme Hızı	Min. 2.5 mm/tag/day/gün (23°C - %50 B.N.)	
Bruchdehnung/Elongation at Break/Kopma Uzaması	≥ 400 %	(ASTM D412)
(Transparent und Aluminium/Transparent and Aluminum/ Şeffaf ve Alüminyum)		
Bruchdehnung/Elongation at Break/Kopma Uzaması (Andere Farben/Other Colors/Diğer Renkler)	≥ 350 %	(ASTM D412)
Elastische Rückkehr/Elastic Return/Elastik Geri Dönüş	~ %100	(ISO 7389)
Durchhängen/Sag/Sarkma	0 mm	(ISO 7390)
Temperaturbeständigkeit/Temperature resistance/Sıcaklık dayanımı	-60°C / +180°C	
Anwendungstemperatur/Application Temperature/Üyulama Sıcaklığı	+5°C ile / +40°C	

Die angegebenen Werte wurden in einer Umgebung mit 23 ± 2 °C und 50 ± 5 % Luftfeuchtigkeit ermittelt./The stated values were obtained in an environment containing 23±2°C and 50±5% humidity.
Belirtilen değerler 23±2°C ve %50±5 nem içeren ortamda elde edilmiştir.

FLEXI
ELASTISCHER MASTIC/
ELASTIC MASTIC/
ELASTİK MASTİK



Chemischer Natur /Chemical nature/Kimyasal yapısı	AST-Polymer / AST Polymer/ AST Polimer	
Aushärtemechanismus /Curing Mechanism/Kürleşme Mekanizması	mit Feuchtigkeit / with humidity / Nem ile	
Dichte /Density/Yoğunluk	0,96-0,98 g/ml	
Aussehen-Farbe /Appearance-Color/Görünüm-Renk	Paste - Weiß, Schwarz, Grau /Paste - White, Black, Gray/Pasta-Beyaz, Siyah, Gri	
Verkrustungszeit (1 cm) /Encrusting Time (1 cm)/Kabuk Bağlama Süresi (1 cm)	~ 60 min/dk. (23°C - %50 B.N.)	
Härtungsleistung /Curing Performance/Kürleşme Performansı	-2,50 mm/24 stunde/hours/saat (23°C-%50 B.N.)	
Fließend /Flowing/Akma	0 mm	(ISO 7390)
Shore A Härte / Hardness/Sertlik	25+5	(ISO 868)
E100 Modul /Module/Modülü	< 0,4 N/mm ²	(ISO 8339)
Bruchdehnung /Elongation at Break/Kopma Uzaması	≥ 350 %	(ISO 37)
Volumenverlust /Volume Loss/Hacim Kaybı	< -%3 (23°C-%50 R.H.)	
Zerreißeigenschaft /Tensile Strength/Çekme Dayanımı	1,0-1,5 N/mm ²	(ISO 37)
Temperaturbeständigkeit /Temperature resistance/Sıcaklık dayanımı	-40°C / +90°C	
Anwendungstemperatur /Application Temperature/Uygulama Sıcaklığı	+5°C ile / +40°C	

MULTI SEAL
ALLGEMEINES DICHTUNGS- UND KLEBSTOFF/
GENERAL PURPOSE SEALANT AND ADHESIVE/
GENEL AMAÇLI MASTİK VE YAPIŞTIRICI



Chemischer Natur /Chemical nature/Kimyasal yapısı	AST-Polymer / AST Polymer/ AST Polimer	
Aushärtemechanismus /Curing Mechanism/Kürleşme Mekanizması	mit Feuchtigkeit / with humidity / Nem ile	
Dichte /Density/Yoğunluk	1,60-0,03 g/ml	
Konsistenz-Farbe /Consistency-Color/Kıvam-Renk	Thixotrope Paste - Weiß, Schwarz, Grau / Thixotropic Paste - White, Black, Gray/ Tiksotropik Pasta-Beyaz, Siyah, Gri	
Shore A Härte / Hardness/Sertlik	40+5	
Fließend /Flowing/Akma	0 mm	
Verkrustungszeit /Encrusting Time/Kabuk Bağlama Süresi	12-25 min/dk. (23°C - %50 B.N.)	
Aushärtgeschwindigkeit /Curing Speed/Kürleşme Hızı	Min. 2,5 mm/tag/day/gün (23°C - %50 B.N.)	
Nicht ziehen /Shrinkage/Çekme	< 3%	
Bruchdehnung /Elongation at Break/Kopma Uzaması	≥ 300 %	
Zerreißeigenschaft /Tensile Strength/Çekme Dayanımı	1,5-2,0 N/mm ²	
Anwendungstemperatur /Application Temperature/Uygulama Sıcaklığı	+5°C ile / +40°C	
Temperaturbeständigkeit /Temperature resistance/Sıcaklık dayanımı	-40°C / +90°C	

647FC
ULTRA-POLYURETHAN-DICHTSTOFF
(BAU - BAU - AUTOMOBİL)/
ULTRA POLYURETHANE SEALANT
(CONSTRUCTION - CONSTRUCTION - AUTOMOTIVE)/
ULTRA POLİÜRETAN MASTİK
(YAPI - İNŞAAT - OTOMOTİV)



VORHÄRTEN/PRE-CURING/KÜRLEŞME ÖNCESİ		
Chemischer Natur /Chemical nature/Kimyasal yapısı	Auf Polyurethanbasis /Polyurethane Based/ Poliüretan Esaslı	
Form	Thixotrope Paste /Thixotropic Paste/ Tiksotropik Macun	
Aushärtemechanismus /Curing Mechanism/Kürleşme Mekanizması	mit Feuchtigkeit / with humidity / Nem ile	
Dichte /Density/Yoğunluk	1,08-0,03 g/ml	
Oberflächentrocknungszeit /Surface Drying Time/Yüzey Kuruma Süresi	40+10 min/dk. (23°C - %60 B.N.)	
Aushärtgeschwindigkeit /Curing Speed/Kürleşme Hızı	Min. 3 mm/tag/day/gün (23°C - %50 B.N.)	
Fließend /Flowing/Akma	0 mm	(EN ISO 7390)
Temperaturbeständigkeit /Temperature resistance/Sıcaklık dayanımı	-40°C / +90°C	
Anwendungstemperatur /Application Temperature/Uygulama Sıcaklığı	+5°C ile / +40°C	
NACH DEM AUSHÄRTEN/AFTER CURING/KÜRLEŞME SONRASI		
Shore A Härte / Hardness/Sertlik	45-50 (28 Tag später/day later/gün sonra)	
Lackierbarkeit /Paintability/Boyanabilirlik	Ja /Yes/Evet	
Bruchdehnung /Elongation at Break/Kopma Uzaması	≥ 300 %	(ISO 37)
Zerreißeigenschaft /Tensile strength/Berilme Direnci	Min. 2,5 N/mm ²	(ISO 37)

AS606
SILIKONISIERTES DICHUNGSMITTEL/
SILICONIZED SEALANT/
SİLİKONİZE MASTİK



Chemischer Natur /Chemical nature/Kimyasal yapısı	Acrylemulsion /Acrylic Emulsion/Akrilik Emülsiyon	
Konsistenz /Consistency/Kıvam	Paste /Pasta	
pH	7-8	
Dichte /Density/Yoğunluk	1,63+1,65 g/ml	(ISO 1183)
Verkrustungszeit /Encrusting Time/Kabuk Bağlama Süresi	50-20 min/dk. (23°C - %50 B.N.)	(ASTM C679)
Aushärtgeschwindigkeit /Curing Speed/Kürleşme Hızı	2 mm/tag/day/gün (23°C - %50 B.N.)	
Shore A Härte / Hardness/Sertlik	30-50	(DIN 53505)
Elastizität /Elasticity/Elastikiyet	≥ 300	(DIN 53504)
E100 Modul /Module/Modülü	0,55 kg/cm ²	
Max. betonen/stress/gerilme Mpa/mm ²	>0,01	(ISO 8339)
Temperaturbeständigkeit /Temperature resistance/Sıcaklık dayanımı	-10°C / +80°C	
Anwendungstemperatur /Application Temperature/Uygulama Sıcaklığı	+5°C ile / +40°C	

805
ALLGEMEINER ZWECK SCHAUM/
GENERAL PURPOSE FOAM/
GENEL AMAÇLI KÖPÜK



Chemischer Natur /Chemical nature/Kimyasal yapısı	Polyurethan / Polyurethane/ Poliüretan	
Aushärtemechanismus /Curing Mechanism/Kürleşme Mekanizması	mit Feuchtigkeit / with humidity / Nem ile	
Dichte /Density/Yoğunluk	22+3 kg/m ³	(ASTM D1622)
Verkrustungszeit (1 cm) /Encrusting Time (1 cm)/Kabuk Bağlama Süresi (1 cm)	7+3 min/dk.	(ASTM C1620)
Schnittzeit (1cm) /Cutting Time (1cm)/ Kesilebilme Süresi (1cm)	30-45 min/dk.	(ASTM C1620)
Aushärtezeit /Curing Time/ Kürleşme Süresi	24 Stunden /Hours/Saat	
Schaumfarbe /Foam Color/Köpük Rengi	Hellgelb /Light yellow/Açık Sarı	
Ausbeute /Yield/Verim	30-45L	(ASTM C1536)
Erweiterungsbetrag /Expansion amount/Genleşme miktar	% 200 - 250	
Auszahlungsbetrag /Withdrawal amount/Çekme miktar	0 %	
Verbrennungsklasse /Combustion Class/Yanma Sınıfı	B3	(DIN 4102)
Wärmeleitfähigkeit /Thermal Conductivity/Termal iletkenlik	0,036 W/m.k (bei/at 20°C/de)	(DIN 52612)
Druckfestigkeit /Compressive Strength/Basing Dayanımı	0,03 MPa	(DIN 53421)
Wasseraufnahme /Water Absorption/Su Emme	Max. %1 Nach Volumen/By volume/Hacimce	(DIN 53428)
Temperaturbeständigkeit /Temperature resistance/Sıcaklık dayanımı	-40°C / +80°C	
Anwendungstemperatur /Application Temperature/Uygulama Sıcaklığı	-2°C ile / +30°C	
Zinn temperatur /Tin Temperature/Tenke Sıcaklığı	+5°C ile / +30°C	

Die angegebenen Werte wurden in einer Umgebung mit 23 ± 2 °C und 50 ± 5 % Luftfeuchtigkeit ermittelt./The stated values were obtained in an environment containing 23±2°C and 50±5% humidity./
Belirtilen değerler 23±2°C ve %50±5 nem içeren ortamda elde edilmiştir.

805P
PROFESSIONELLER SCHAUM/
PROFESSIONAL FOAM/
PROFESYONEL KÖPÜK



940
SCHAUM MIT MECHANISCHEM VENTIL/
FOAM WITH MECHANICAL VALVE/
MEKANİK VALFLİ KÖPÜK



806
TÜR- UND FENSTERSCHAUM/
DOOR AND WINDOW FOAM/
KAPI VE PENCERE KÖPÜĞÜ



960
XPS-, EPS- und WÄRMEDÄMMPLATTEN
KLEBESCHAUM/
XPS, EPS and THERMAL INSULATION BOARDS
ADHESIVE FOAM/
XPS, EPS ve ISI YALITIM LEVHALARI
YAPIŞTIRICI KÖPÜK



SOUDAL SOUDAFLEX 40FC 600 ML
SCHWARZES POLYURETHAN-DICHTMITTEL/
BLACK POLYURETHANE SEALANT/
SİYAH POLİÜRETAN MASTİK



Chemischer Natur/Chemical nature/Kimyasal yapısı	Polyurethan/ Polyurethane/ Poliüretan	
Aushärtemechanismus/Curing Mechanism/Kürleşme Mekanizması	mit Feuchtigkeit / with humidity / Nem ile	
Dichte/Density/Yoğunluk	19+3 kg/m ³	(ASTM D1622)
Verkrustungszeit (1 cm)/Encrusting Time (1 cm)/Kabuk Bağlama Süresi (1 cm)	6+2 min/dk.	(ASTM C1620)
Schnittzeit (1cm)/Cutting Time (1cm)/ Kesilebilme Süresi (1cm)	20-45 min/dk.	(ASTM C1620)
Aushärtezeit/Curing Time/ Kürleşme Süresi	24 Stunden/Hours/Saat	
Schaumfarbe/Foam Color/Köpük Rengi	Hellgelb/Light yellow/Açık Sarı	
Ausbeute/Yield/Verim	30-45L	(ASTM C1536)
Erweiterungsbetrag/Expansion amount/Genleşme miktar	Max. % 30	
Auszahlungsbetrag/Withdrawal amount/Cekme miktar	0 %	
Verbrennungsklasse/Combustion Class/Yanma Sınıfı	B3	(DIN 4102-1)
Wärmeleitfähigkeit/Thermal Conductivity/Termal İletkenlik	0,036 W/m.k (bei/at 20 °C/de)	(DIN 52612)
Druckfestigkeit/Compressive Strength/Basınç Dayanımı	0,03 MPa	(DIN 53421)
Wasseraufnahme/Water Absorption/Su Emme	Max. %1 Nach Volumen/By volume/Hacimce	(DIN 53428)
Temperaturbeständigkeit/Temperature resistance/Sıcaklık dayanımı	-40 °C / +80 °C	
Anwendungstemperatur/Application Temperature/Uygulama Sıcaklığı	-2 °C ile / +30 °C	
Zinnntemperatur/Tin Temperature/Teneke Sıcaklığı	+5 °C ile / +30 °C	

Chemischer Natur/Chemical nature/Kimyasal yapısı	Polyurethan/ Polyurethane/ Poliüretan	
Aushärtemechanismus/Curing Mechanism/Kürleşme Mekanizması	mit Feuchtigkeit / with humidity / Nem ile	
Dichte/Density/Yoğunluk	22+3 kg/m ³	(ASTM D1622)
Verkrustungszeit (1 cm)/Encrusting Time (1 cm)/Kabuk Bağlama Süresi (1 cm)	7+3 min/dk.	(ASTM C1620)
Schnittzeit (1cm)/Cutting Time (1cm)/ Kesilebilme Süresi (1cm)	30-45 min/dk.	(ASTM C1620)
Aushärtezeit/Curing Time/ Kürleşme Süresi	24 Stunden/Hours/Saat	
Schaumfarbe/Foam Color/Köpük Rengi	Hellgrün/Light green/Açık Yeşil	
Ausbeute/Yield/Verim	30-45L	(ASTM C1536)
Erweiterungsbetrag/Expansion amount/Genleşme miktar	% 250	
Auszahlungsbetrag/Withdrawal amount/Cekme miktar	0 %	
Verbrennungsklasse/Combustion Class/Yanma Sınıfı	B3	(DIN 4102)
Wärmeleitfähigkeit/Thermal Conductivity/Termal İletkenlik	0,036 W/m.k (bei/at 20 °C/de)	(DIN 52612)
Druckfestigkeit/Compressive Strength/Basınç Dayanımı	0,03 MPa	(DIN 53421)
Wasseraufnahme/Water Absorption/Su Emme	Max. %1 Nach Volumen/By volume/Hacimce	(DIN 53428)
Temperaturbeständigkeit/Temperature resistance/Sıcaklık dayanımı	-40 °C / +80 °C	
Anwendungstemperatur/Application Temperature/Uygulama Sıcaklığı	+5 °C ile / +30 °C	
Zinnntemperatur/Tin Temperature/Teneke Sıcaklığı	+5 °C ile / +30 °C	

Chemischer Natur/Chemical nature/Kimyasal yapısı	Polyurethan/ Polyurethane/ Poliüretan	
Aushärtemechanismus/Curing Mechanism/Kürleşme Mekanizması	mit Feuchtigkeit / with humidity / Nem ile	
Dichte/Density/Yoğunluk	22+3 kg/m ³	(ASTM D1622)
Verkrustungszeit (1 cm)/Encrusting Time (1 cm)/Kabuk Bağlama Süresi (1 cm)	7+2 min/dk.	(ASTM C1620)
Schnittzeit (1cm)/Cutting Time (1cm)/ Kesilebilme Süresi (1cm)	20-45 min/dk.	(ASTM C1620)
Aushärtezeit/Curing Time/ Kürleşme Süresi	24 Stunden/Hours/Saat	
Schaumfarbe/Foam Color/Köpük Rengi	Hellgelb/Light yellow/Açık Sarı	
Ausbeute/Yield/Verim	30-45L	(ASTM C1536)
Erweiterungsbetrag/Expansion amount/Genleşme miktar	Max. % 200	
Auszahlungsbetrag/Withdrawal amount/Cekme miktar	0 %	
Verbrennungsklasse/Combustion Class/Yanma Sınıfı	B3	(DIN 4102)
Wärmeleitfähigkeit/Thermal Conductivity/Termal İletkenlik	0,036 W/m.k (bei/at 20 °C/de)	(DIN 52612)
Druckfestigkeit/Compressive Strength/Basınç Dayanımı	0,03 MPa	(DIN 53421)
Wasseraufnahme/Water Absorption/Su Emme	Max. %1 Nach Volumen/By volume/Hacimce	(DIN 53428)
Temperaturbeständigkeit/Temperature resistance/Sıcaklık dayanımı	-40 °C / +80 °C	
Anwendungstemperatur/Application Temperature/Uygulama Sıcaklığı	+5 °C ile / +30 °C	
Zinnntemperatur/Tin Temperature/Teneke Sıcaklığı	+5 °C ile / +30 °C	

Chemischer Natur/Chemical nature/Kimyasal yapısı	Polyurethan/ Polyurethane/ Poliüretan	
Aushärtemechanismus/Curing Mechanism/Kürleşme Mekanizması	mit Feuchtigkeit / with humidity / Nem ile	
Dichte/Density/Yoğunluk	22+3 kg/m ³	(ASTM D1622)
Verkrustungszeit (1 cm)/Encrusting Time (1 cm)/Kabuk Bağlama Süresi (1 cm)	6+2 min/dk.	(ASTM C1620)
Schnittzeit (1cm)/Cutting Time (1cm)/ Kesilebilme Süresi (1cm)	20-45 min/dk.	(ASTM C1620)
Aushärtezeit/Curing Time/ Kürleşme Süresi	24 Stunden/Hours/Saat	
Schaumfarbe/Foam Color/Köpük Rengi	Rosa/Pink/Pembe	
Ausbeute/Yield/Verim	30-45L	(ASTM C1536)
Mertic-Ausbeute/Mertic Yield/Mertik Verim	=9 m ²	
Bruchdehnung/Elongation at Break/Kopma Uzaması	13,6 %	
Erweiterungsbetrag/Expansion amount/Genleşme miktar	Minimal	
Auszahlungsbetrag/Withdrawal amount/Cekme miktar	0 %	
Verbrennungsklasse/Combustion Class/Yanma Sınıfı	B3	(DIN 4102-1)
Wärmeleitfähigkeit/Thermal Conductivity/Termal İletkenlik	0,036 W/m.k (bei/at 20 °C/de)	(DIN 52612)
Druckfestigkeit/Compressive Strength/Basınç Dayanımı	0,03 MPa	(DIN 53421)
Zerreißeftigkeit/Tensile strength/Genilme Direnci	7,6 N/cm ²	
Temperaturbeständigkeit/Temperature resistance/Sıcaklık dayanımı	-40 °C / +100 °C	
Anwendungstemperatur/Application Temperature/Uygulama Sıcaklığı	0 °C ile / +30 °C	

Chemischer Natur/Chemical nature/Kimyasal yapısı	Polyurethan/Polyurethane/Poliüretan	
Konsistenz/Consistency/Kıvam	Paste/Macun	
Farbe/Color/Renk	Schwarz/Black/Siyah	
Trocknungssystem/Drying System/Kurutma Sistemi	Feuchtigkeitskur/Moisture cure/Nem kuru	
Gewebebildung(*) (20 °C/65% RH)/Tissue formation/Doku oluşumu	~ 15 min/dk.	
Trocknungsgeschwindigkeit(*) (20 °C/65% RH)/Drying rate/Kuruma hızı	2 mm/24 Stunden/Hours/Saat	
Shore A Härte/ Hardness/Sertlik	40 + 5	(DIN 53505)
Spezifisches Gewicht/Specific gravity/Uzgül ağırlık	1,30 g/ml	(DIN 53479)
Max. zulässige Degradation/Max. allowable degradation/ İzin verilen maks. bozunma	20%	
Flexibler Fallback/Flexible fallback/Esnek geri dönme	>80%	(ISO 7389)
Elastizitätsmodul 100%/Modulus of Elasticity/Elastisite Modülü	0,80 N/mm ²	(DIN 53504)
Maximale Spannung/Maximum tension/Maksimum gerilim	1,70 N/mm ²	(DIN 53504)
Bruchdehnung/Elongation at break/Kopma anındaki uzama	>700%	(DIN 53504)
Temperaturbeständigkeit/Temperature resistance/Sıcaklık dayanımı	-30 °C / +90 °C	
Anwendungstemperatur/Application Temperature/Uygulama Sıcaklığı	+5 °C ile / +35 °C	

Die angegebenen Werte wurden in einer Umgebung mit 23 + 2 °C und 50 + 5 % Luftfeuchtigkeit ermittelt./The stated values were obtained in an environment containing 23+2°C and 50+5% humidity./
Belirtilen değerler 23+2°C ve %50+5 nem içeren ortamda elde edilmiştir.

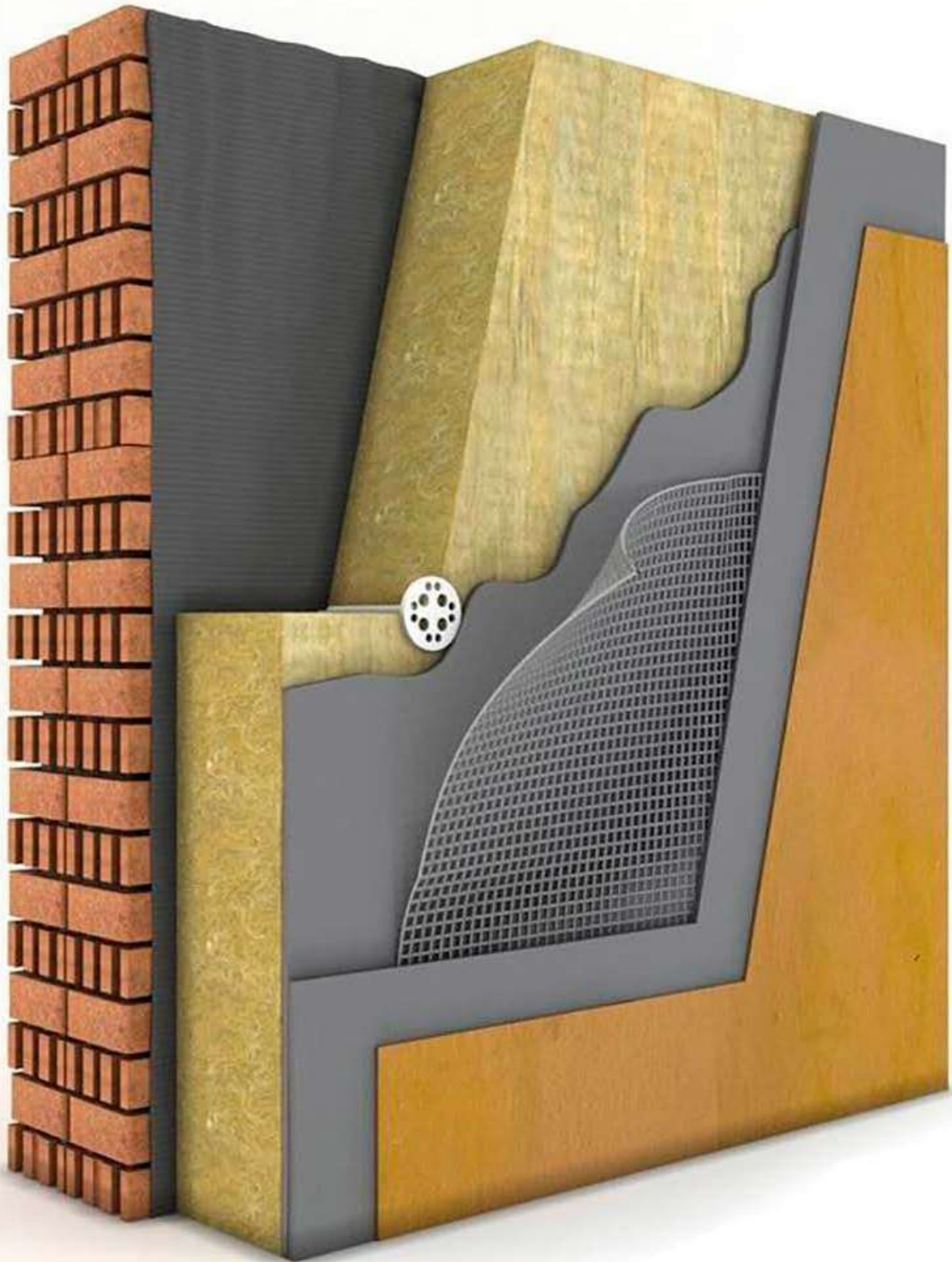

FASSADEN-ZUBEHÖR
FACADE ACCESSORIES
CEPHE AKSESUAR



GZBC-0 GASBETONANKER MIT STAHLNÄGELN / GAS CONCRETE ANCHOR WITH STEEL NAILS / GAZ BETON DÜBELİ ÇELİK ÇİVİLİ



EVMT-01 EURO SCHRAUBENANKER DOCLE / EURO SCREW ANCHOR DOCLE / EURO VİDALI MEKANİK TIRNAKLI DÜBEL



MTLDB-01 METALLANKER MIT KUNSTSTOFFKOPF / METAL ANCHOR WITH PLASTIC HEAD / METAL DÜBEL PLASTİK BAŞLIKLİ



OSBV-01 OSB-UND AUSSENBSCHICHTUNGSPLATTE ANKER MIT SCHRAUBE / OSB AND EXTERIOR COATING PLATE ANCHORS WITH SCREW / OSB VE DIŞ CEPHE KAPLAMA LEVHA DÜBELLERİ VİDALI

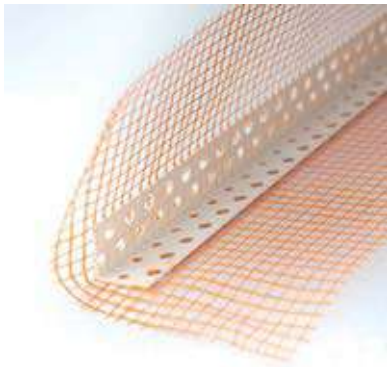

ECKENPROFIL MIT MESH / CORNER PROFILE WITH MESH / FİLELİ KÖŞE PROFİLİ

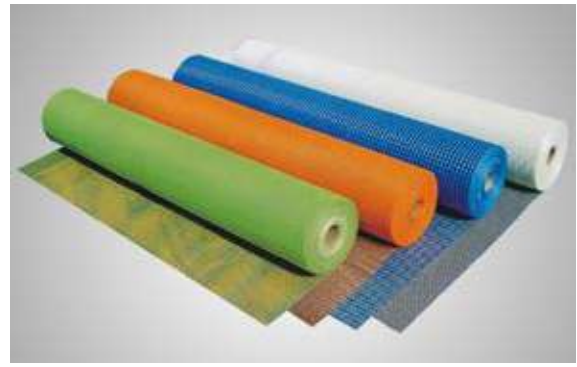

GIPSNETZ / PLASTER NET / SIVA FİLESİ



WASSERDICHTER ABDECKUNGEN
WATERPROOFING COVERS
SU YALITIM ÖRTÜLERİ



P03000 POLYMER BITUMINÖSE WASSERDICHTUNGSGEWEBE/
POLYMER BITUMINOUS WATERPROOFING MESH/
POLİMER BİTÜMLÜ SU YALITIM ÖRTÜSÜ



ELASTOBIT POLYMER BITUMINÖSE WASSERDICHTUNGSGEWEBE/
POLYMER BITUMINOUS WATERPROOFING MESH/
POLİMER BİTÜMLÜ SU YALITIM ÖRTÜSÜ



PLASTOBIT POLYMER BITUMINÖSE WASSERDICHTUNGSGEWEBE/
POLYMER BITUMINOUS WATERPROOFING MESH/
POLİMER BİTÜMLÜ SU YALITIM ÖRTÜSÜ



POLIBITO POLYMER BITUMINÖSE WASSERDICHTUNGSGEWEBE/
POLYMER BITUMINOUS WATERPROOFING MESH/
POLİMER BİTÜMLÜ SU YALITIM ÖRTÜSÜ



BOTANIK BITUMINÖSES WASSERDICHTUNGSMATERIAL WIDERSTANDSFÄHIG
GEGEN PFLANZENWURZELN / BITUMINOUS WATERPROOFING MATERIAL RESISTANT
TO PLANT ROOTS / BİTKİ KÖKLERİNE DAYANIKLI BİTÜMLÜ SU YALITIM ÖRTÜSÜ



LOVOBIT POLYMER BITUMINÖSE WASSERDICHTUNGSGEWEBE/
POLYMER BITUMINOUS WATERPROOFING MESH/
POLİMER BİTÜMLÜ SU YALITIM ÖRTÜSÜ



ARBEITER-UNIFORMEN
WORKER UNIFORMS
İŞ ELBİSELERİ



HELM / HELMET / BARET



HANDSCHUH / GLOVE / ELDİVEN



BOOT / BOT



JACKEN / JACKETS / MONT



WESTE / WAISTCOAT / YELEK



OVERALL / OVERALLS / TULUM



DRAHT- UND ZAUNSYSTEME
WIRE MESH AND FENCE SYSTEMS
TEL ÖRGÜ VE ÇİT SİSTEMLERİ



**PANEELZAUN/PANEL FENCE/
PANEL ÇİT**



**2D DOPPELFELDZAUN/2D DOUBLE PANEL FENCE/
2D DOUBLE PANEL ÇİT**



**3D DOPPELFELDZAUN/3D DOUBLE PANEL FENCE/
3D DOUBLE PANEL ÇİT**



**HOCHSICHERHEITZAUN/HIGH SECURITY FENCE/
YÜKSEK GÜVENLİK ÇİT**



**GABIONENSYSTEM/GABION SYSTEM/
GABİON SİSTEMİ**



**GRASZAUN/GRASS FENCE/
ÇİM ÇİT**



**VERZINKT DRAHTGEHÄUSE/GALVANIZED WIRE MESH/
GALVANİZLİ TEL ÖRGÜ**



**PVC-BESCHICHTETES DRAHTGEWEBE/PVC COATED
WIRE MESH/ PVC KAPLI TEL ÖRGÜ**



**VERZINKTER GEWEBEDRAHT/GALVANIZED MESH
WIRE/GALVANİZ HASIR TEL**



**SECHSKANTDRAHT/HEXAGON WIRE/
ALTIGEN TEL**



**STACHELDRAHT/BARBED WIRE/
DİKENLİ TEL**



**PLANE SHARP DRAHT/PLANE SHARP WIRE/
DÜZLEMSEL JİLETLİ TEL**



HEIZKÖRPER
RADIATORS
RADYATÖRLER



SLIMRAD-75H



SLIMRAD-75V



SLIMRAD-100VL



BASALTWÜRFEL STEIN
BASALT CUBE STONE
BAZALT KÜP TAŞI

BASALTWÜRFEL STEIN / BASALT CUBE STONE / BAZALT KÜP TAŞI



BASALTWÜRFEL STEIN / BASALT CUBE STONE / BAZALT KÜP TAŞI

PRODUKT / PRODUCT / ÜRÜN	MESSUNG / MEASUREMENT / ÖLÇÜ
	4 x 6 cm
	6 x 8 cm
	8 x 10 cm
	10 x 20 cm

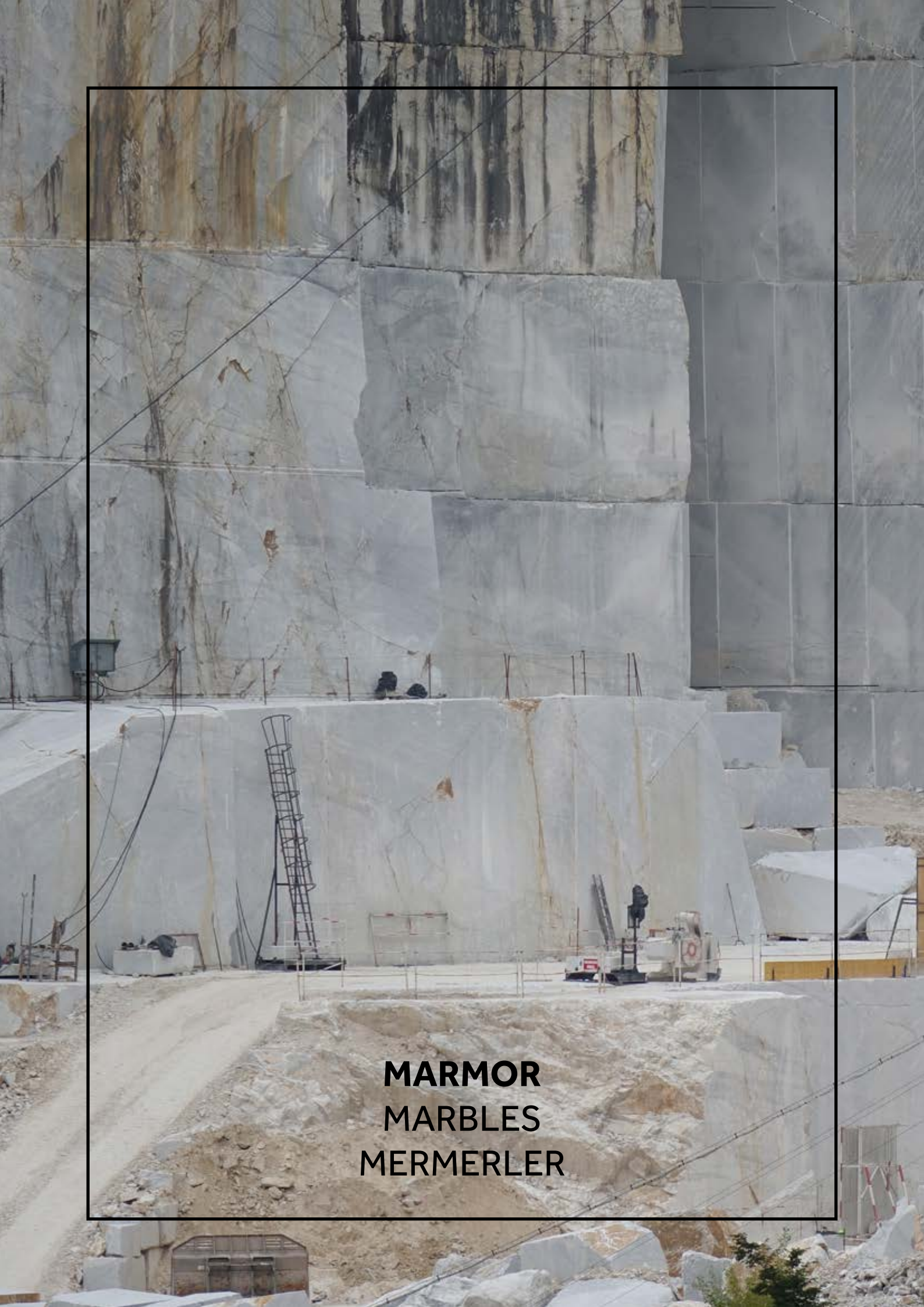

MARMOR
MARBLES
MERMERLER



ADIYAMAN LIGHT EMPERADOR



AFYON BEYAZ



AFYON GRI



SUPREM



AKSEHIR SIYAH



ALEXANDRETTE BLACK

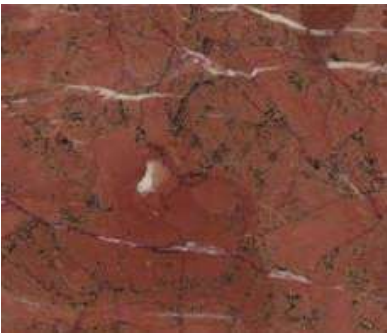

ANATOLIAN RED



ATHENS GREY



BEYAZ TRAVERTEN



BIANCO CARRARA

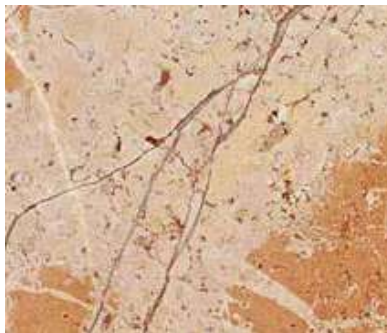

BILECIK PEMBE



BURDUR BEJ



UNSERE PARTNER
OUR PARTNERS
İŞ ORTAKLARIMIZ



KRK BAUSTOFFE

"Geheimnis der Meister"

Çakmaklı Mah. Memleket Cad. No: 20
B y kcekmece / İSTANBUL
www.krk-bau.de | www.krk-bau.com